



# ROSSOFUOCO®

*Forni a legna & Barbecues*  
*Wood burning ovens & Barbecues*



Collezione 2020 Collection  
con listino 01.2020 - with price list 01.2020



“Le cose fatte con amore sono sempre ben fatte,  
e hanno il dono di farsi amare.”

*Così, con tutta la nostra passione sogniamo, pensiamo, creiamo e produciamo i nostri forni, realizzando qualcosa capace di farsi subito amare.*

 **ROSSOFUOCO**<sup>®</sup>  
*Forni a Legna & Barbecues*  
*Wood burning ovens & Barbecues*

## Nel cuore della Tradizione

Forse non tutti oggi hanno ricordo dell'importanza che il forno a legna ebbe nella tradizione culinaria italiana, quando le donne delle famiglie contadine vi cuocevano il pane, le carni i dolci e tutte quelle prelibatezze genuine da cui è nata la fama della cucina italiana nel mondo.

Oggi i moderni forni a legna danno a tutti la possibilità di riscoprire quegli antichi sapori in modo davvero semplice.

Perhaps few people know the importance that the wood-fired oven had in the Italian culinary tradition.

The women of pleasant families cooked in the wood ovens bread, meats, desserts and many other genuine delicacies. The fame in the world of Italian cuisine was born thanks to those women and their wood ovens. Today, modern wood-burning ovens give everyone the opportunity to rediscover those ancient flavors in a really simple way.

In the heart of  
Tradition

quality made in Italy

**100%** Made  
in Italy

Rossofuoco's products are renowned for their reliability, for great range of models that meet every need, without disappointing any expectations. The distribution network is very effective with well selected sales points, where professional retailers operate to ensure, at all times, the full satisfaction of the customer.

Many reasons that justify the full recognition of our company, in Italy and all over the world.

By choosing a Rossofuoco's oven you buy a product entirely made in Italy, with quality and reliability of all materials used, verified in every production step.

5 years warranty

**5** anni di Garanzia  
su camere di cottura e combustione  
on baking and cooking chambers  
**years warranty**

All our separated combustion ovens come with a 5 years warranty on baking and combustion chambers.

Only who is sure of his product can give so much. A certainty that comes from strict production standards.

To achieve this, Rossofuoco® uses skilled designers and expert technicians.

qualità made in Italy

I prodotti Rossofuoco® sono rinomati per la loro affidabilità e per la varietà della gamma, fatta di prodotti mirati a soddisfare molteplici esigenze senza deludere le aspettative.

La rete distributiva è quanto mai efficace con punti vendita ben selezionati dove operano rivenditori professionisti che lavorano per assicurare in ogni momento la piena soddisfazione del cliente.

Sono tante le ragioni che giustificano il pieno riconoscimento di ROSSOFUOCO®, in Italia e nel mondo.

Un'azienda che quotidianamente verifica la qualità dei processi produttivi, dei materiali, dell'affidabilità dei componenti, sempre pronta ad intervenire, anche direttamente, all'insorgere di qualsiasi problema.

garanzia di 5 anni

Cinque anni di garanzia sulle camere di cottura e di combustione di tutti i forni a combustione separata. Solo chi è sicuro del proprio prodotto può garantire tanto.

Una certezza che deriva da processi di fabbricazione secondo gli standard più rigorosi per dare sicurezza ai clienti, accompagnata dalla reperibilità per lungo tempo dei pezzi di ricambio.

Per ottenere ciò ROSSOFUOCO® si avvale di abili professionisti per la progettazione e tecnici esperti per la costruzione dei propri forni a legna.

simplicity

The system of the cooking chamber separated from the combustion one, that avoids food contact with smoke **does not requires familiarity** in regulating the quantity of wood necessary to obtain the right temperature, that can be reached and mantained even by adding more of it later.

The oven can reach the right temperature in only 30/40 minutes, with just 3/4 kg of wood, keeping this temperature stable for over 2 hours after the end of combustion.



Il sistema a camera di combustione separata da quella di cottura, che evita il contatto dei cibi con i fumi, **non richiede dimestichezza** nel regolare la quantità di legna per ottenere la giusta temperatura che, si può raggiungere o mantenere anche aggiungendone successivamente dell'altra.

Ne bastano 3/4kg per raggiungere la temperatura d'impiego in soli 30/40 minuti, rimanendo pressochè costante per oltre 2 ore dopo la fine della combustione.

**The combustion intensity can be adjusted** using the smoke valve by which it may be modified the draft, or by varying the opening of the ventilation slots in the combustion chamber door.



**L'intensità della combustione è regolabile** utilizzando la valvola fumi con cui modificare il "tiraggio", o variando l'apertura delle feritoie di areazione nello sportello della camera di combustione.

**The humidity in the cooking chamber can be adjusted**, with the steam valve, while ventilation further improves the internal heat distribution for cooking.



**La valvola vapori aiuta a dosare l'umidità** nella camera di cottura, mentre la ventilazione migliora ulteriormente la distribuzione del calore per la cottura.

The electrical connection to the home network with the 12volt transformer makes it possible to use the lamp inside the oven and the ventilation, but working in complete safety.



Il collegamento elettrico alla rete domestica con il trasformatore a 12volt permette di utilizzare la lampada di illuminazione interna al forno e la ventilazione, in tutta sicurezza.

semplicità

added value

To obtain exceptional cooking qualities, the ROSSOFUOCO® separated combustion ovens are built **with an exclusive internal heat distribution system** where the flame never reaches the walls of the cooking chamber because to be heated is the dividing radiant panel placed between the combustion chamber and cooking one (1); in this cavity the heated air starts its natural circulation movement by "convection" filtering through a series of slits placed at the sides of the lower level of the cooking chamber (2) where it spreads uniformly reaching and heating each level.

This is the reason why with our ovens it is possible to cook very well even when the ventilation is off.

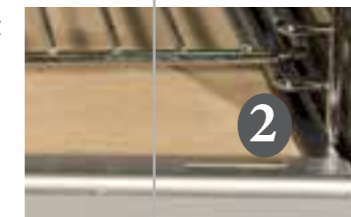
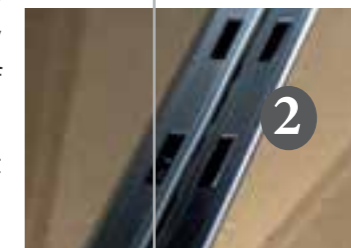
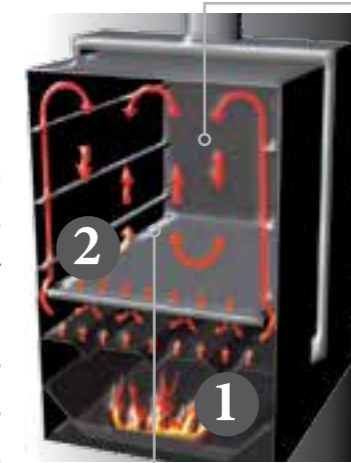

In our separate combustion ovens, the cooking chamber is squared instead of vaulted, so there is more space to place the food, even on three grills at the same time, with perfect results.

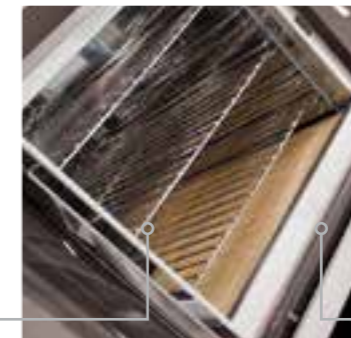

ROSSOFUOCO® ovens are available in a wide range of models entirely made in Italy with top quality materials and components along with a five-year warranty on the cooking and combustion chambers of the models with separated combustion system.



valore aggiunto

Per ottenere qualità di cottura eccezionali i forni a combustione separata ROSSOFUOCO® sono costruiti **con un sistema esclusivo di distribuzione interna del calore.**

La fiamma non entra mai a contatto diretto con la camera di cottura perché ad essere riscaldato è il pannello radiante divisorio posto tra camera di combustione e camera di cottura (1); in questa intercapedine l'aria riscaldata inizia il suo movimento di circolazione naturale per "convezione" filtrando attraverso la serie di feritoie poste ai lati del piano inferiore della camera di cottura (2) dove si diffonde uniformemente raggiungendo e riscaldando omogeneamente ogni livello; anche per questo con i nostri forni è possibile cuocere ottimamente le pietanze persino a ventilazione spenta.

La camera di cottura è quadrata anziché a volta, così lo spazio per posizionare le pietanze è più ampio e la cottura, in ogni piano, è sempre perfetta anche se li si utilizza tutti contemporaneamente.

I forni ROSSOFUOCO® sono disponibili in un'ampia gamma di modelli interamente fatti in Italia con materiali e componenti di primissima qualità insieme a ben cinque anni di garanzia su camere di cottura e combustione dei modelli a combustione separata.

## The Details

### Ergonomic "cool-grip" handles

Made to avoid risks of burns and to have an easy front clamping system.

### Anti tilting grids

All the ovens come with 2 or 3 grids that can be placed on one of the 5 level with double rack.

### Baking chamber without weldings

Made out of stainless steel it is free from unhealthy weldings; it's beautiful and really undeformable by thermal shocks.

### No weldings between baking and combustion chambers

This avoid abnormal deformations due to different dilatation of different materials caused by heat.

### Stainless steel hingers

They are fixed on the body parts and not simply on the front panel of the oven; so the lock is perfect also during high dilatation phases.

### Eco-friendly varnishes

For the best possible respect of the enviroment.

### Safe 12 volts electrical system

A transformer converts the standard house current to a safe 12 volts one.

### Low consumption

High performances with only 3/4 kg of wood.



## I Dettagli

### Maniglie "antiscotto"

Riducono il pericolo di scottature durante l'uso; il loro sistema a serraggio frontale garantiscono una chiusura perfetta.

### Griglie antiribaltamento

2 o 3 a seconda del modello e posizionabili sui 5 livelli disponibili, possono essere fatte scorrere lungo le guide senza pericoli.

### Camera di cottura senza saldature

Realizzata in acciaio inox risulta più bella, più robusta, indeformabile agli shock termici.

### Nessuna saldatura tra camere di cottura e combustione

Evita che per il calore le dilatazioni differenti di materiali diversi alterino le camere stesse.

### Cerniere in acciaio Inox

Sono fissate al contro telaio anziché al frontale, garantendo una tenuta migliore anche in fase di forti dilatazioni.

### Vernici ecologiche

Per il massimo rispetto possibile dell'ambiente.

### Impianto elettrico più sicuro

A 12 volt, grazie al trasformatore in dotazione.

### Basso consumo

Prestazioni elevate con soli 3/4 kg di legna.

## easy maintenance

To allow a perfect and deep cleaning of the baking chamber it's possible to dismount the lateral supports of the grids by easily unlocking them from the fixing points.



The baking chamber without grids and supports.

## manutenzione facile

Per una perfetta ed accurata pulizia della camera di cottura, in acciaio inox autopulente, e raggiungerne più facilmente tutti gli angoli, è possibile smontare i supporti laterali delle griglie, sganciandoli dai loro punti di fissaggio con estrema facilità.

La camera di cottura priva di griglie e supporti



ROSSOFUOCO® ovens can be completely dismantled for total inspection and replacement of components. The interventions can all be made from the front (fundamental detail in built-in models).

For example, to replace the fan, just open the cooking chamber, unhook the flange at the bottom, loosen the two fixing screws of the fan-motor block, unhook it, remove it and provide for the intervention.

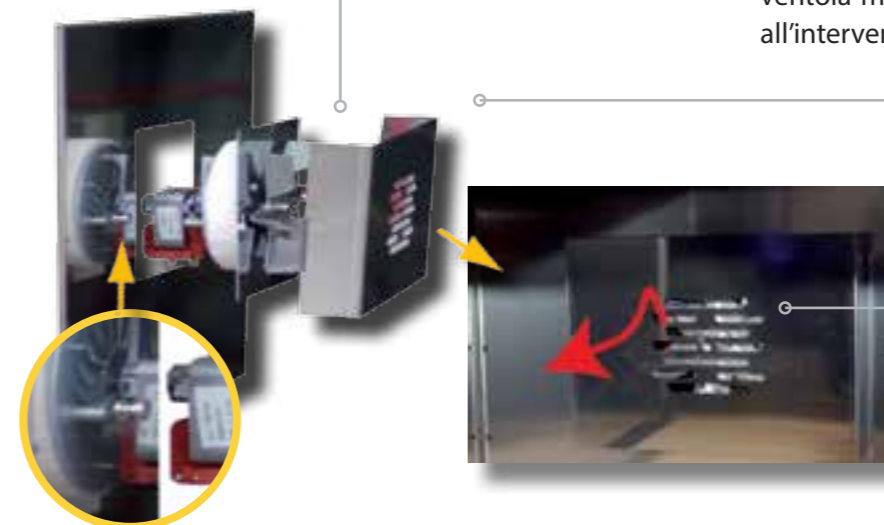

I forni ROSSOFUOCO® sono completamente smontabili per la totale ispezionabilità e per la sostituzione della componentistica.

Gli interventi avvengono tutti dal frontale (particolare fondamentale nei modelli da incasso).

Ad esempio per la sostituzione della ventola basta aprire la camera di cottura, sganciare la flangia posta in fondo, allentare le due viti di fissaggio del blocco ventola-motore, sganciarlo, sfilarlo e provvedere all'intervento.

Il fondo della camera di cottura con la flangia da sganciare.

The bottom of the cooking chamber with the flange to unhook.

# Standard and Optional Equipments

ROSSOFUOCO® ovens are rich in equipments and accessories, such as ventilation system, smoke and steam valves, timer and thermometer, internal lighting, grills, trays, refractory plate, pan holder tool, poker, shovel for bread or pizza, the glove. Depending on the models many are standard, some others are available as an option.

Each oven is equipped with a special ash pan for easy cleaning.

They can also be equipped with cart, work tops, side or front barbecue.

# Le Dotazioni e gli Accessori

I forni a combustione separata ROSSOFUOCO® sono ricchi di dotazioni ed accessori, come la ventilazione, le valvole fumi e vapori, il timer e il termometro, l'illuminazione interna, le griglie, le teglie, l'accessorio prenditeglie, l'attizzatoio, la pala per pane o pizza, il guanto. A seconda dei modelli molti di questi sono di serie, alcuni altri sono disponibili come opzionali.

Ogni forno è dotato di un apposito cassetto raccogli cenere che ne facilita la pulizia.

Possono essere dotati anche di carrelli, di piani di lavoro, di barbecue laterale o frontale.



## FORNI A COMBUSTIONE SEPARATA PER ESTERNO OUTDOOR SEPARATED COMBUSTION OVENS

|                                  |       |
|----------------------------------|-------|
| Sedicioni Inox - black - country | 12-17 |
| Steel                            | 18-19 |
| Fiamma                           | 20-21 |
| Effe                             | 22-23 |
| Raggio                           | 24-25 |
| Garden - Garden Plus             | 26-27 |
| Garden Color                     | 28-29 |
| Eco & Eco 50                     | 30-31 |



## FORNI A COMBUSTIONE SEPARATA DA INCASSO BUILT IN SEPARATED COMBUSTION OVENS

|                                  |       |
|----------------------------------|-------|
| Sedicioni Inox - black - country | 34-39 |
| Steel                            | 44-41 |
| Fiamma                           | 42-43 |
| Rame                             | 42-43 |
| Red                              | 44-45 |
| Effe                             | 46-47 |
| Eco                              | 48-49 |
| Eco 50                           | 48-49 |
| Garden color                     | 50-51 |
| Quattrostagioni                  | 52-53 |



## FORNI A COTTURA DIRETTA PER ESTERNO OUTDOOR DIRECT COOKING OVENS

|              |       |
|--------------|-------|
| Più trecento | 56-57 |
| Nonna Luisa  | 58-59 |
| Benni        | 60-61 |
| Campagnolo   | 62-63 |
| Mino         | 64-65 |



## BARBECUE BARBECUES

|                                      |       |
|--------------------------------------|-------|
| Easy Up (standalone)                 | 68-69 |
| Maxi (standalone)                    | 70-71 |
| Falò (per forni / for ovens)         | 72-73 |
| Cassetto BBQ (per forni / for ovens) | 72-73 |



## RISCALDATORI PIROLITICI PER ESTERNO OUTDOOR PYROLYTIC PATIO HEATERS

|          |       |
|----------|-------|
| Rubino   | 76-77 |
| Diamante | 78-79 |



## ACCESSORI E RICAMBI EQUIPMENTS AND SPARE PARTS

|                              |       |
|------------------------------|-------|
| Accessori / Equipment        | 82-89 |
| Ricambi / Spare parts        | 90-94 |
| Tabella colori / Color chart | 95    |



**FORNI A COMBUSTIONE SEPARATA  
DA ESTERNO**

---

**OUTDOOR  
SEPARATED COMBUSTION OVENS**

|                                  |       |
|----------------------------------|-------|
| Sedicioni Inox - black - country | 12-17 |
| Steel                            | 18-19 |
| Fiamma                           | 20-21 |
| Effe                             | 22-23 |
| Raggio                           | 24-25 |
| Garden - Garden Plus             | 26-27 |
| Garden Color                     | 28-29 |
| Eco                              | 30-31 |
| Eco 50                           | 30-31 |

# Sedicioni Inox

la praticità della camera di cottura orizzontale

great ease with the ultra-wide cooking chamber



**5** anni di Garanzia  
su camera di cottura e combustione  
on baking and cooking chambers  
years warranty

**100%** Made  
in Italy

## DOTAZIONI DI SERIE

Carrello, **doppia ventilazione**, valvole fumi e vapori, termometro, timer, illuminazione interna, 3 griglie cromate, 2 teglie rettangolari, accessorio prenditeghe, attizzatoio, comignolo antivento, guanto e presina.

## STANDARD EQUIPMENT

Cart, **double ventilation fan**, smoke and steam valves, thermometer, timer, internal lighting, 3 chrome grilles, 2 rectangular baking pans, pan holder tool, poker, windproof chimney, oven mitt and pan holder.

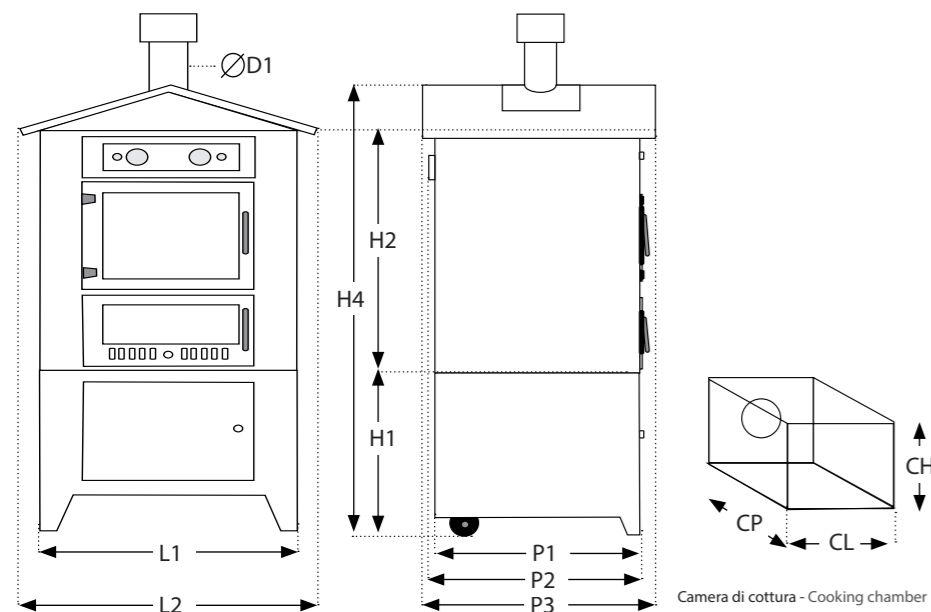

Camera di cottura - Cooking chamber

| Codice modello<br>Item code | L1   | L2   | P1  | P2  | P3   | H1  | H2   | H4   | KG  | D1  | CL  | CP  | CH  | Carica legna<br>Wood load | Prezzo<br>Price |
|-----------------------------|------|------|-----|-----|------|-----|------|------|-----|-----|-----|-----|-----|---------------------------|-----------------|
| Sedicioni 80A-CC            | 1005 | 1250 | 780 | 820 | 1070 | 640 | 1000 | 1820 | 272 | 130 | 730 | 630 | 390 | 3/4 Kg.                   |                 |

Dimensioni in millimetri, peso in Kg. - Dimensions in millimeters, weight in Kg.

Prezzi iva esclusa / Prices are VAT or Taxes excluded

| Listino accessori / Accessories price list                            |                | Iva esclusa / VAT or Taxes excluded |  |
|---|----------------|-------------------------------------|--|
| Articolo<br>Item  | Codice<br>Code | Prezzo<br>Price                     |  |
| Barbecue laterale Falò / Side barbecue "Falò"                         | BEF            |                                     |  |
| Barbecue: Supplemento tetto inox / Surcharge for stainless steel roof | BTX            |                                     |  |
| Barbecue: Opzione griglia inox / Surcharge for stainless steel grid   | GBX65X         |                                     |  |
| Piano di lavoro frontale / Front work top                             | PFW            |                                     |  |
| Kit 6 pale e portapale / Kit of 6 shovels with shovel holder          |                |                                     |  |

Trovi altri accessori  
a pagina 86:  
piano di lavoro laterale,  
piastra refrattaria aggiuntiva,  
pale pane pizza,  
porta pale,  
griglie e teglie aggiuntive,  
cappottine....

More accessories  
at page 86:  
lateral work top,  
additional refractory plate,  
bread and pizza shovels,  
shovel holder,  
additional grilles and pans,  
waterproof cover....

# FORNI A COMBUSTIONE SEPARATA DA ESTERNO

OUTDOOR SEPARATED COMBUSTION OVENS

# Sedicioni Inox



Finiture in acciaio inox - Tetto inox - Camera di cottura sviluppata orizzontalmente - Camere di cottura e combustione con vetro a specchio.  
Stainless steel front panels - Stainless steel roof - Horizontal layout of the cooking chamber - Doors with mirrored glass.

Gli accessori più richiesti

The most popular accessories



Set pale / Shovels kit



Barbecue



Piano lavoro/Work top



Kit "Porchetta"





# Sedicinoni Black

sceglilo insieme al grande barbecue a legna

choose it together with the large wood-burning barbecue



**5** anni di Garanzia  
su camere di cottura e combustione  
on baking and cooking chambers  
years warranty

**100%** Made  
in Italy

## DOTAZIONI DI SERIE

Carrello, **doppia ventilazione**, valvole fumi e vapori, termometro, timer, illuminazione interna, 3 griglie cromate, 2 teglie rettangolari, accessorio prenditeglie, attizzatoio, comignolo antivento, guanto e presina.

## STANDARD EQUIPMENT

Cart, **double ventilation fan**, smoke and steam valves, thermometer, timer, internal lighting, 3 chrome grilles, 2 rectangular baking pans, pan holder tool, poker, windproof chimney, oven mitt and pan holder.

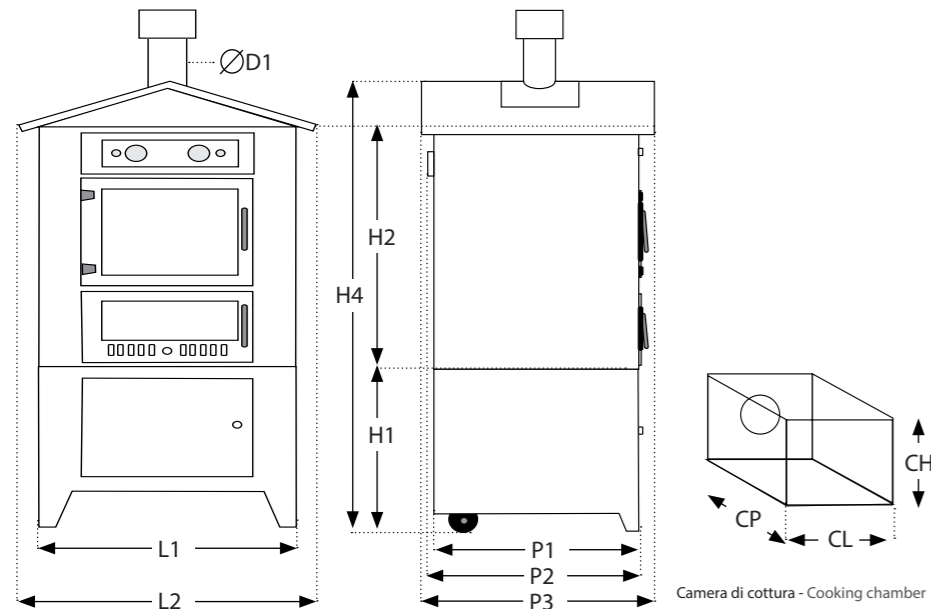

Camera di cottura - Cooking chamber

| Codice modello<br>Item code | L1   | L2   | P1  | P2  | P3   | H1  | H2   | H4   | KG  | D1  | CL  | CP  | CH  | Carica legna<br>Wood load | Prezzo<br>Price |
|-----------------------------|------|------|-----|-----|------|-----|------|------|-----|-----|-----|-----|-----|---------------------------|-----------------|
| Sedicinoni 80B-CC           | 1005 | 1250 | 780 | 820 | 1070 | 640 | 1000 | 1820 | 272 | 130 | 730 | 630 | 390 | 3/4 Kg.                   |                 |

*Dimensioni in millimetri, peso in Kg. - Dimensions in millimeters, weight in Kg.      Prezzi Iva esclusa / Prices are VAT or Taxes excluded*

| Listino accessori / Accessories price list                            |                | Iva esclusa / VAT or Taxes excluded |  |
|---|----------------|-------------------------------------|--|
| Articolo<br>Item  | Codice<br>Code | Prezzo<br>Price                     |  |
| Barbecue laterale Falò / Side barbecue "Falò"                         | BEF            |                                     |  |
| Barbecue: Supplemento tetto inox / Surcharge for stainless steel roof | BTX            |                                     |  |
| Barbecue: Opzione griglia inox / Surcharge for stainless steel grid   | GBX65X         |                                     |  |
| Piano di lavoro frontale / Front work top                             | PFW            |                                     |  |
| Kit 6 pale e portapale / Kit of 6 shovels with shovel holder          |                |                                     |  |

Trovi altri accessori  
a pagina 86:  
piano di lavoro laterale,  
piastra refrattaria aggiuntiva,  
pale pane pizza,  
porta pale,  
griglie e teglie aggiuntive,  
cappottine....

More accessories  
at page 86:  
lateral work top,  
additional refractory plate,  
bread and pizza shovels,  
shovel holder,  
additional grilles and pans,  
waterproof cover....

# FORNI A COMBUSTIONE SEPARATA DA ESTERNO

OUTDOOR SEPARATED COMBUSTION OVENS

# Sedicinoni Black



Verniciatura nera - Tetto inox - Camera di cottura sviluppata orizzontalmente - Doppia ventilazione.

Black color painted - Stainless steel roof - Horizontal layout of the cooking chamber - Double ventilation fan.



Gli accessori  
più richiesti

The most popular  
accessories



Piano lavoro/Work top



Kit "Porchetta"



Piana refrattaria aggiuntiva  
Additional refractory plate



Pala/ Shovel

# Sedicinoni Country

la praticità della camera di cottura orizzontale

great ease with the ultra-wide cooking chamber



**5** anni di Garanzia  
su camera di cottura e combustione  
on baking and cooking chambers  
years warranty

**100%** Made  
in Italy

## DOTAZIONI DI SERIE

Carrello, **doppia ventilazione**, valvole fumi e vapori, termometro, timer, illuminazione interna, 3 griglie cromate, 2 teglie rettangolari, accessorio prenditeglie, attizzatoio, comignolo antivento, guanto e presina.

## STANDARD EQUIPMENT

Cart, **double ventilation fan**, smoke and steam valves, thermometer, timer, internal lighting, 3 chrome grilles, 2 rectangular baking pans, pan holder tool, poker, windproof chimney, oven mitt and pan holder.

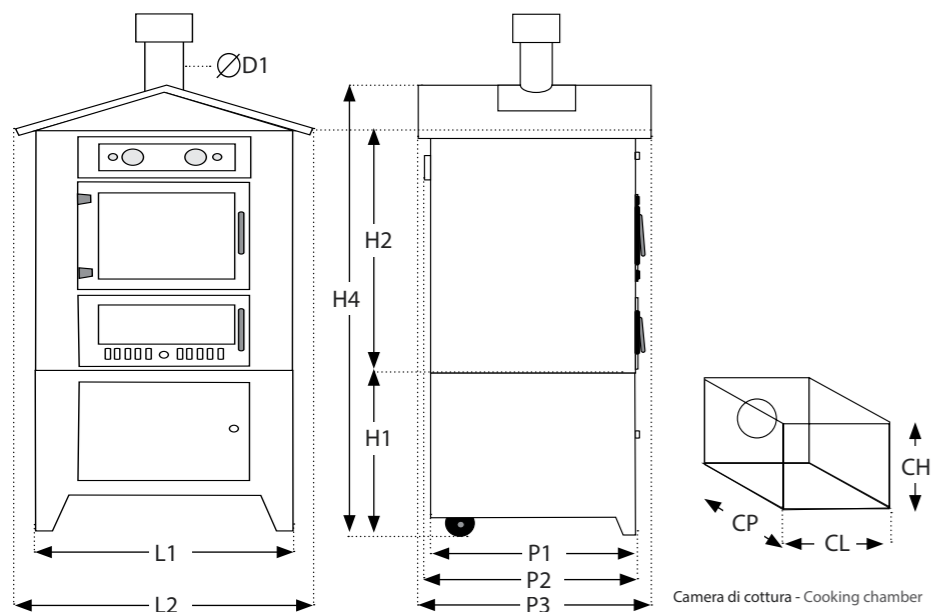

| Codice modello<br>Item code | L1   | L2   | P1  | P2  | P3   | H1  | H2   | H4   | KG  | D1  | CL  | CP  | CH  | Carica legna<br>Wood load | Prezzo<br>Price |
|-----------------------------|------|------|-----|-----|------|-----|------|------|-----|-----|-----|-----|-----|---------------------------|-----------------|
| Sedicinoni 80C-CC           | 1005 | 1250 | 780 | 820 | 1070 | 640 | 1000 | 1820 | 272 | 130 | 730 | 630 | 390 | 3/4 Kg.                   |                 |

Dimensioni in millimetri, peso in Kg. - Dimensions in millimeters, weight in Kg. Prezzi Iva esclusa / Prices are VAT or Taxes excluded

| Listino accessori / Accessories price list                            |                | Iva esclusa / VAT or Taxes excluded |  |
|---|----------------|-------------------------------------|--|
| Articolo<br>Item  | Codice<br>Code | Prezzo<br>Price                     |  |
| Barbecue laterale Falò / Side barbecue "Falò"                         | BEF            |                                     |  |
| Barbecue: Supplemento tetto inox / Surcharge for stainless steel roof | BTX            |                                     |  |
| Barbecue: Opzione griglia inox / Surcharge for stainless steel grid   | GBX65X         |                                     |  |
| Piano di lavoro frontale / Front work top                             | PFW            |                                     |  |
| Kit 6 pale e portapale / Kit of 6 shovels with shovel holder          |                |                                     |  |

Trovi altri accessori  
a pagina 86:  
piano di lavoro laterale,  
piastra refrattaria aggiuntiva,  
pale pane pizza,  
porta pale,  
griglie e teglie aggiuntive,  
cappottine....

More accessories  
at page 86:  
lateral work top,  
additional refractory plate,  
bread and pizza shovels,  
shovel holder,  
additional grilles and pans,  
waterproof cover....

# FORNI A COMBUSTIONE SEPARATA DA ESTERNO

OUTDOOR SEPARATED COMBUSTION OVENS

# Sedicinoni Country



Verniciatura marrone - Tetto inox - Camera di cottura sviluppata orizzontalmente - Doppia ventilazione.

Brown color painted - Stainless steel roof - Horizontal layout of the cooking chamber - Double ventilation fan.

Gli accessori più richiesti

The most popular accessories



Set pale / Shovels kit



Barbecue



Piano lavoro/Work top



Kit "Porchetta"



# Steel

la forza e la bellezza dell'acciaio

the strenght and the beauty of steel

**5** anni di Garanzia  
su camere di cottura e combustione  
on baking and cooking chambers  
years warranty

**100%** Made  
in Italy



## DOTAZIONI DI SERIE

Carrello, ventilazione, valvole fumi e vapori, termometro, timer, illuminazione interna, 3 griglie cromate, 1 teglia rettangolare, 2 teglie rotonde, accessorio prenditeghe, attizzatoio, comignolo antivento, guanto e presina.

## STANDARD EQUIPMENT

Cart, ventilation fan, smoke and steam valves, thermometer, timer, internal lighting, 3 chrome grilles, 1 rectangular baking pan, 2 round baking pans, pan holder tool, poker, windproof chimney, oven mitt and pan holder.

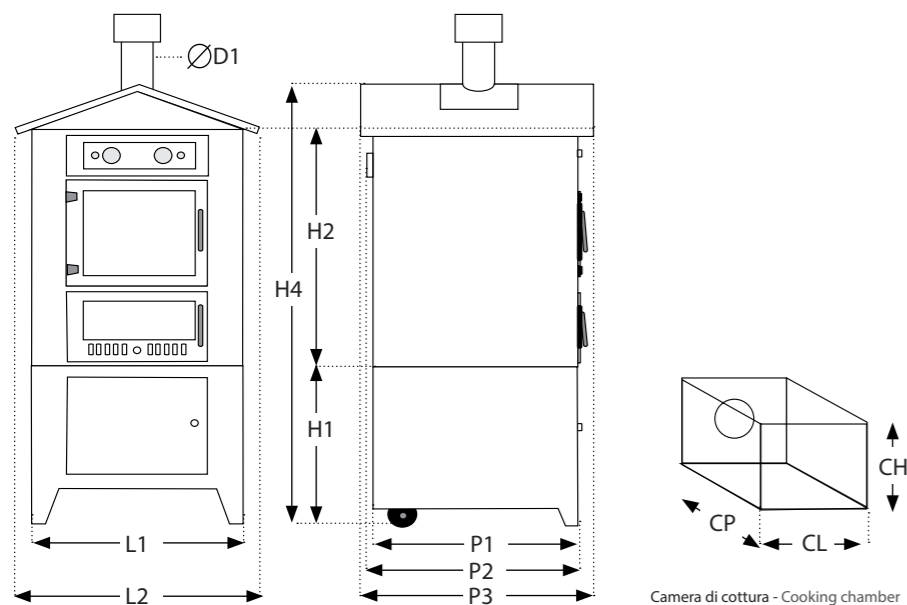

Camera di cottura - Cooking chamber

| Codice modello<br>Item code | L1  | L2   | P1   | P2   | P3   | H1  | H2  | H4   | KG* | D1  | CL  | CP   | CH  | Carica legna<br>Wood load | Prezzo<br>Price |
|-----------------------------|-----|------|------|------|------|-----|-----|------|-----|-----|-----|------|-----|---------------------------|-----------------|
| Steel 65-CC                 | 755 | 1000 | 775  | 815  | 1050 | 650 | 980 | 1770 | 229 | 130 | 480 | 650  | 420 | 3 kg.                     |                 |
| Steel 80-CC                 | 805 | 1060 | 930  | 970  | 1180 | 650 | 980 | 1770 | 266 | 130 | 480 | 800  | 420 | 3/4 kg                    |                 |
| Steel 100-CC                | 805 | 1060 | 1120 | 1160 | 1380 | 650 | 980 | 1770 | 320 | 130 | 480 | 1000 | 420 | 4 kg                      |                 |

Dimensioni in millimetri, peso in Kg. - Dimensions in millimeters, weight in Kg.

Prezzi Iva esclusa / Prices are VAT or Taxes excluded

| Listino accessori / Accessories price list                          |  |                                 |                                     | Iva esclusa / VAT or Taxes excluded |  |
|---|--|---------------------------------|-------------------------------------|-------------------------------------|--|
| Per<br>For  | Barbecue laterale "Falò"<br>Side barbecue "Falò" | Piano laterale<br>Side work top | Kit Porchetta<br>Kit for big roasts |                                     |  |
| Steel 65-CC   | BEF  | PA 65                           | GP65KIT                             |                                     |  |
| Steel 80-CC   | BEF  | PA 80/100                       | GP80KIT                             |                                     |  |
| Steel 100-CC  | BEF  | PA 80/100                       | GP100KIT                            |                                     |  |
| Barbecue: Opzione tetto inox / Surcharge for stainless steel roof   |  |                                 |                                     | BTX                                 |  |
| Barbecue: Opzione griglia inox / Surcharge for stainless steel grid |  |                                 |                                     | GBX65X                              |  |

Trovi altri accessori  
a pagina 86:  
mensola frontale,  
piastra refrattaria aggiuntiva,  
pale pane pizza,  
porta pale,  
griglie e teglie aggiuntive,  
cappottine....

More accessories  
at page 86:  
front shelf,  
additional refractory plate,  
bread and pizza shovels,  
shovel holder,  
additional grilles and pans,  
waterproof cover....

# FORNI A COMBUSTIONE SEPARATA DA ESTERNO

OUTDOOR SEPARATED COMBUSTION OVENS

Steel

Struttura frontale acciaio inox - Tetto Inox - Vetri a specchio nelle camere di cottura e combustione.

Stainless steel front panels - Stainless steel roof - Doors with mirrored glass.

Gli accessori più richiesti

The most popular accessories



Set pale / Shovels kit



Barbecue



Piano lavoro/Work top



Kit "Porchetta"





**5** anni di Garanzia  
su camere di cottura e combustione  
on baking and cooking chambers  
years warranty

**100%** Made  
in Italy

**DOTAZIONI DI SERIE**

Carrello, ventilazione, valvole fumi e vapori, termometro, timer, illuminazione interna, 3 griglie cromate, 1 teglia rettangolare, 2 teglie rotonde, accessorio prenditeglie, attizzatoio, comignolo antivento, guanto e presina.

**STANDARD EQUIPMENT**

Cart, ventilation fan, smoke and steam valves, thermometer, timer, internal lighting, 3 chrome grilles, 1 rectangular baking pan, 2 round baking pans, pan holder tool, poker, windproof chimney, oven mitt and pan holder.

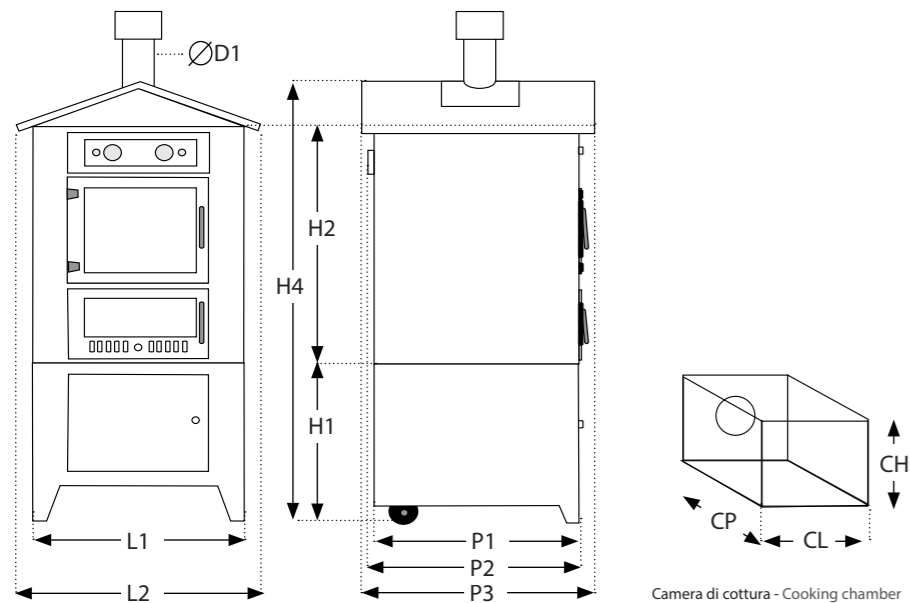

| Codice modello<br>Item code | L1  | L2   | P1   | P2   | P3   | H1  | H2  | H4   | KG* | D1  | CL  | CP   | CH  | Carica legna<br>Wood load | Prezzo<br>Price |
|-----------------------------|-----|------|------|------|------|-----|-----|------|-----|-----|-----|------|-----|---------------------------|-----------------|
| Fiamma 65-CC                | 755 | 1000 | 775  | 815  | 1050 | 650 | 980 | 1770 | 229 | 130 | 480 | 650  | 420 | 3 kg.                     |                 |
| Fiamma 80-CC                | 805 | 1060 | 930  | 970  | 1180 | 650 | 980 | 1770 | 266 | 130 | 480 | 800  | 420 | 3/4 kg                    |                 |
| Fiamma 100-CC               | 805 | 1060 | 1120 | 1160 | 1380 | 650 | 980 | 1770 | 320 | 130 | 480 | 1000 | 420 | 4 kg                      |                 |

Dimensioni in millimetri, peso in Kg. - Dimensions in millimeters, weight in Kg.

Prezzi Iva esclusa / Prices are VAT or Taxes excluded

| Listino accessori / Accessories price list                          |  |                                 |                                     | Iva esclusa / VAT or Taxes excluded |  |
|---|--|---------------------------------|-------------------------------------|-------------------------------------|--|
| Per<br>For  | Barbecue laterale "Falò"<br>Side barbecue "Falò" | Piano laterale<br>Side work top | Kit Porchetta<br>Kit for big roasts |                                     |  |
| Fiamma 65-CC  | BEF  | 0                               | PA 65                               | GP65KIT                             |  |
| Fiamma 80-CC  | BEF  |                                 | PA 80/100                           | GP80KIT                             |  |
| Fiamma 100-CC   | BEF  |                                 | PA 80/100                           | GP100KIT                            |  |
| Barbecue: Opzione tetto inox / Surcharge for stainless steel roof   |  |                                 |                                     | BTX                                 |  |
| Barbecue: Opzione griglia inox / Surcharge for stainless steel grid |  |                                 |                                     | GBX65X                              |  |

Trovi altri accessori a pagina 86:  
mensola frontale,  
piastra refrattaria aggiuntiva,  
pale pane pizza,  
porta pale,  
griglie e teglie aggiuntive,  
cappottine....

More accessories at page 86:  
front shelf,  
additional refractory plate,  
bread and pizza shovels,  
shovel holder,  
additional grilles and pans,  
waterproof cover....

**FORNI A COMBUSTIONE SEPARATA DA ESTERNO**  
OUTDOOR SEPARATED COMBUSTION OVENS

Struttura verniciata - Tetto Inox - Inserti in acciaio inox - Vetri stondati.  
Body painted - Stainless steel roof - Stainless steel finishes - Rounded glasses.

Gli accessori più richiesti

The most popular accessories



Set pale / Shovels kit



Barbecue



Piano lavoro/Work top



Kit "Porchetta"



Effe

solida bellezza e massima efficienza

solid beauty and maximum efficiency



**5** anni di Garanzia  
su camere di cottura e combustione  
on baking and cooking chambers  
years warranty

**100%** Made  
in Italy

### DOTAZIONI DI SERIE

Carrello, ventilazione, valvole fumi e vapori, termometro, timer, illuminazione interna, 3 griglie cromate, 1 teglia rettangolare, 2 teglie rotonde, accessorio prenditeghe, attizzatoio, comignolo antivento, guanto e presina.

### STANDARD EQUIPMENT

Cart, ventilation fan, smoke and steam valves, thermometer, timer, internal lighting, 3 chrome grilles, 1 rectangular baking pan, 2 round baking pans, pan holder tool, poker, windproof chimney, oven mitt and pan holder.

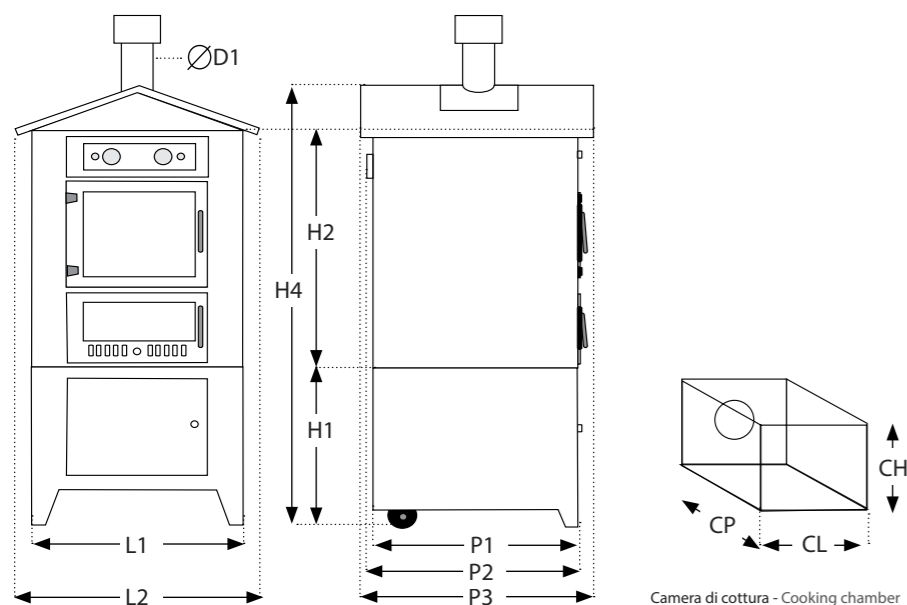

Camera di cottura - Cooking chamber

| Codice modello<br>Item code | L1  | L2   | P1   | P2   | P3   | H1  | H2  | H4   | KG* | D1  | CL  | CP   | CH  | Carica legna<br>Wood load | Prezzo<br>Price |
|-----------------------------|-----|------|------|------|------|-----|-----|------|-----|-----|-----|------|-----|---------------------------|-----------------|
| Effe 65-CC                  | 755 | 1000 | 775  | 815  | 1050 | 650 | 980 | 1770 | 229 | 130 | 480 | 650  | 420 | 3 kg.                     |                 |
| Effe 80-CC                  | 805 | 1060 | 930  | 970  | 1180 | 650 | 980 | 1770 | 266 | 130 | 480 | 800  | 420 | 3/4 kg                    |                 |
| Effe 100-CC                 | 805 | 1060 | 1120 | 1160 | 1380 | 650 | 980 | 1770 | 320 | 130 | 480 | 1000 | 420 | 4 kg                      |                 |

Dimensioni in millimetri, peso in Kg. - Dimensions in millimeters, weight in Kg.

Prezzi Iva esclusa / Prices are VAT or Taxes excluded

| Listino accessori / Accessories price list                          |  |                                 |                                     | Iva esclusa / VAT or Taxes excluded |  |
|---|--|---------------------------------|-------------------------------------|-------------------------------------|--|
| Per<br>For  | Barbecue laterale "Falò"<br>Side barbecue "Falò" | Piano laterale<br>Side work top | Kit Porchetta<br>Kit for big roasts |                                     |  |
| Effe 65-CC  | BEF  | PA 65                           | GP65KIT                             |                                     |  |
| Effe 80-CC  | BEF  | PA 80/100                       | GP80KIT                             |                                     |  |
| Effe 100-CC   | BEF  | PA 80/100                       | GP100KIT                            |                                     |  |
| Barbecue: Opzione tetto inox / Surcharge for stainless steel roof   |  |                                 |                                     | BTX                                 |  |
| Barbecue: Opzione griglia inox / Surcharge for stainless steel grid |  |                                 |                                     | GBX65X                              |  |

Trovi altri accessori  
a pagina 86:  
mensola frontale,  
piastra refrattaria aggiuntiva,  
pale pane pizza,  
porta pale,  
griglie e teglie aggiuntive,  
cappottine....

More accessories  
at page 86:  
front shelf,  
additional refractory plate,  
bread and pizza shovels,  
shovel holder,  
additional grilles and pans,  
waterproof cover....

## FORNI A COMBUSTIONE SEPARATA DA ESTERNO

OUTDOOR SEPARATED COMBUSTION OVENS



Struttura verniciata - Tetto Inox - Bordatura vetri in acciaio inox - Consolle strumenti con ribaltina di protezione.  
Body painted - stainless steel roof - Glasses with steel frame - Control panel protected by tilting lid.

Gli accessori più richiesti

The most popular accessories



Set pale / Shovels kit



Barbecue



Piano lavoro/Work top



Kit "Porchetta"



# Raggio

bello con le sue linee stondate

beautiful with its rounded profiles

**5** anni di Garanzia  
su camere di cottura e combustione  
on baking and cooking chambers  
years warranty

**100%** Made  
in Italy

La mensolina  
frontale  
integrata  
The small  
front  
shovel



## DOTAZIONI DI SERIE

Carrello, ventilazione, valvole fumi e vapori, termometro, timer, illuminazione interna, mensolina frontale, 2 griglie cromate, 1 teglia rettangolare, 1 teglia rotonda, accessorio prenditeghe, attizzatoio, comignolo antivento, guanto e presina.

## STANDARD EQUIPMENT

Cart, ventilation fan, smoke and steam valves, thermometer, timer, internal lighting, small front shelf, 2 chrome grilles, 1 rectangular baking pan, 1 round baking pan, pan holder tool, poker, windproof chimney, oven mitt and pan holder.

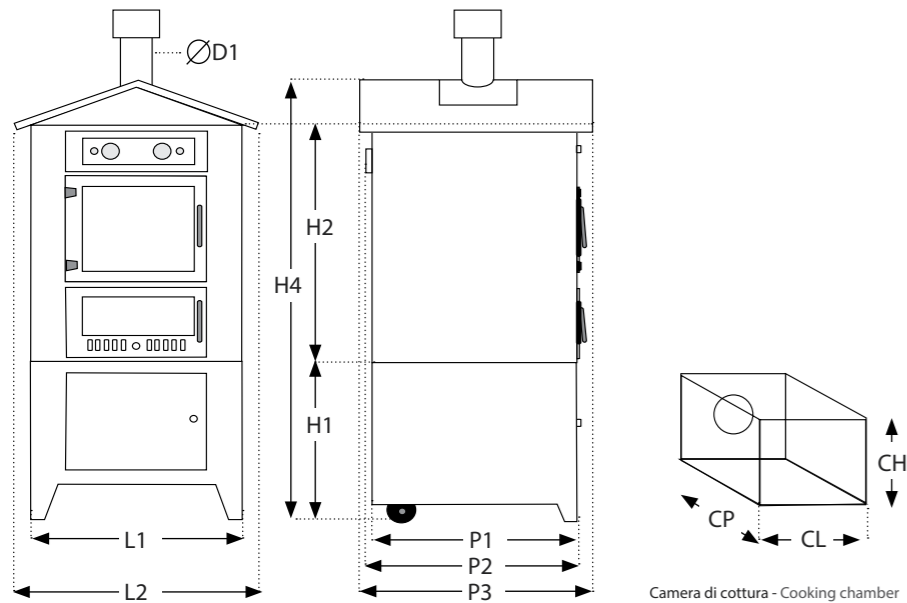

Camera di cottura - Cooking chamber

| Codice modello<br>Item code | L1  | L2  | P1  | P2  | P3   | H1  | H2  | H4   | KG  | D1  | CL  | CP  | CH  | Carica legna<br>Wood load | Prezzo<br>Price |
|-----------------------------|-----|-----|-----|-----|------|-----|-----|------|-----|-----|-----|-----|-----|---------------------------|-----------------|
| Raggio 80-CC                | 750 | 850 | 913 | 953 | 1080 | 641 | 975 | 1765 | 266 | 130 | 480 | 800 | 420 | 3/4 kg                    |                 |

Dimensioni in millimetri, peso in Kg. - Dimensions in millimeters, weight in Kg.

Prezzi Iva esclusa / Prices are VAT or Taxes excluded

| Listino accessori / Accessories price list |  |                                 |                                     | Iva esclusa / VAT or Taxes excluded |  |  |  |
|--|--|---------------------------------|-------------------------------------|-------------------------------------|--|--|--|
| Per<br>For                                 | Barbecue estraibile<br>Pull-out Barbecue | Piano laterale<br>Side work top | Kit Porchetta<br>Kit for big roasts |                                     |  |  |  |
| Raggio 80-CC                               | BCF                                      | PA 80/100                       | GP80KIT                             |                                     |  |  |  |
|  |  |                                 |                                     |                                     |  |  |  |

Trovi altri accessori  
a pagina 86:  
barbecue laterale Falò  
mensola frontale,  
piastra refrattaria aggiuntiva,  
pale pane pizza,  
porta pale,  
griglie e teglie aggiuntive,  
cappottine....

More accessories  
at page 86:  
side barbecue Falò  
front shelf,  
additional refractory plate,  
bread and pizza shovels,  
shovel holder,  
additional grilles and pans,  
waterproof cover....

# FORNI A COMBUSTIONE SEPARATA DA ESTERNO

OUTDOOR SEPARATED COMBUSTION OVENS

**Raggio**

Struttura verniciata Marrone ossido - Tetto nero - Bordatura stondate - Mensolina frontale  
Body Brown Oxide painted - Black painted roof - Rounded edging - Small front shelf



Gli accessori più richiesti

The most popular accessories



Set pale / Shovels kit



Barbecue



Piano lavoro/Work top



Kit "Porchetta"



# Garden & Garden Plus

semplici essenziali funzionali

simply a smart choice

**5** anni di Garanzia  
su camere di cottura e combustione  
on baking and cooking chambers  
years warranty

**100%** Made  
in Italy

Barbecue estraibile opzionale  
Optional pull-out BBQ

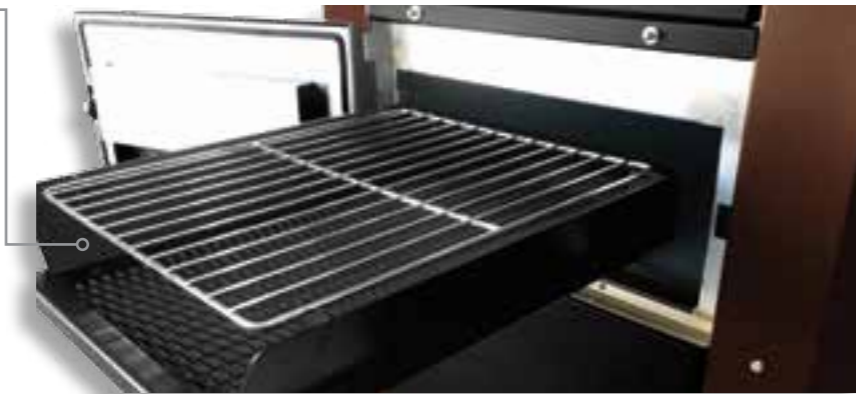

## DOTAZIONI DI SERIE

Carrello integrato nella struttura, ventilazione, valvole fumi e vapori, termometro, illuminazione interna, 2 griglie cromate, 2 teglie, accessorio prenditeglie, attizzatoio, comignolo antivento, guanto e presina.

## STANDARD EQUIPMENT

Cart integrated in the structure, ventilation fan, smoke and steam valves, thermometer, internal lighting, 2 chrome grilles, 2 baking pans, pan holder tool, poker, windproof chimney, oven mitt and pan holder.

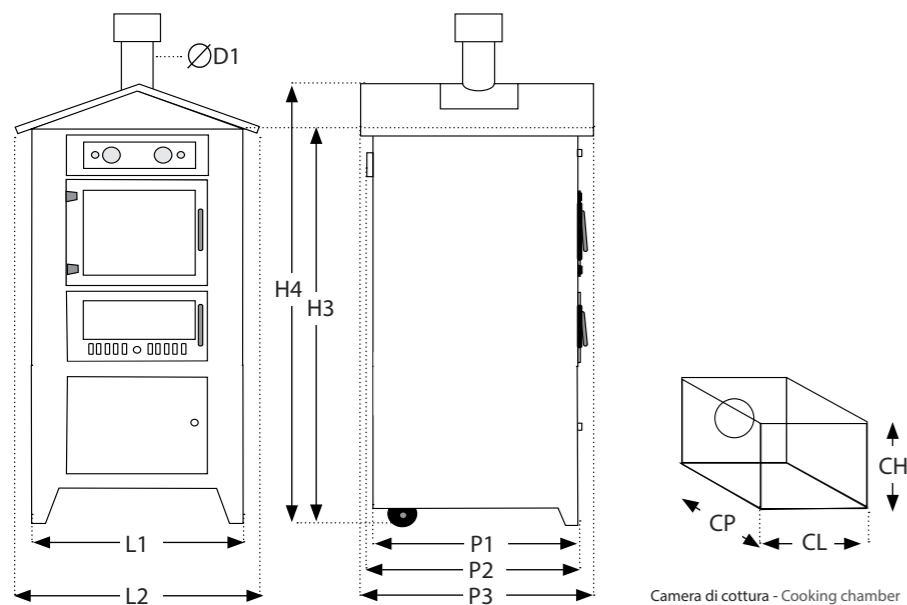

Camera di cottura - Cooking chamber

| Modello Item | Codice Code | L1  | L2   | P1   | P2   | P3   | H3   | H4   | KG  | D1  | CL  | CP   | CH  | Carica legna Wood load | Prezzo Price |
|--------------|-------------|-----|------|------|------|------|------|------|-----|-----|-----|------|-----|------------------------|--------------|
| Garden       | GAR 80      | 755 | 925  | 925  | 965  | 1080 | 1615 | 1755 | 266 | 130 | 480 | 800  | 420 | 3/4 kg                 |              |
|              | GAR 100     | 755 | 925  | 1120 | 1160 | 1280 | 1615 | 1755 | 320 | 130 | 480 | 1000 | 420 | 4 kg                   |              |
| Garden Plus  | GAR 80P     | 755 | 1055 | 925  | 965  | 1160 | 1615 | 1755 | 266 | 130 | 480 | 800  | 420 | 3/4 kg                 |              |
|              | GAR 100P    | 755 | 1055 | 1120 | 1160 | 1380 | 1615 | 1755 | 320 | 130 | 480 | 1000 | 420 | 4 kg                   |              |

Dimensioni in millimetri, peso in Kg. - Dimensions in millimeters, weight in Kg.

Prezzi Iva esclusa / Prices are VAT or Taxes excluded

### Listino accessori / Accessories price list

| Per For  | Barbecue estraibile Pull-out Barbecue | Piana refrattaria aggiuntiva Additional refractory plate | Kit Porchetta Kit for big roasts |
|--|---------------------------------------|--|----------------------------------|
| Garden 80/80Plus   | BCF                                   | PB80   | GP80KIT                          |
| Garden 100/100Plus   | non disp / not available              | PB100  | GP100KIT                         |
| Vetro su camera di combustione / Glass on combustion chamber |                                       |  | GAVTCC                           |
| Plano di lavoro laterale / Side work top                     |                                       |  | PA80/100                         |

Trovi altri accessori a pagina 86:

barbecue laterale Falò mensola frontale, pale pane pizza, porta pale, griglie e teglie aggiuntive, cappottine....

More accessories at page 86:

side barbecue Falò front shelf, bread and pizza shovels, shovel holder, additional grilles and pans, waterproof cover....

# FORNI A COMBUSTIONE SEPARATA DA ESTERNO

OUTDOOR SEPARATED COMBUSTION OVENS

# Garden & Garden Plus



Struttura monoblocco (carrello/forno) verniciata marrone - Garden: tetto verniciato nero - Garden Plus: tetto Inox.  
Brown painted monoblock structure (oven/cart) - Garden: black painted roof - Garden Plus: stainless steel roof.



Porta camera di combustione con vetro opzionale, per entrambi i modelli  
Door of combustion chamber with glass on demand for both models

# Garden Color

pensa a colori

think colored

**5** anni di Garanzia  
su camere di cottura e combustione  
on baking and cooking chambers  
years warranty

**100%** Made  
in Italy

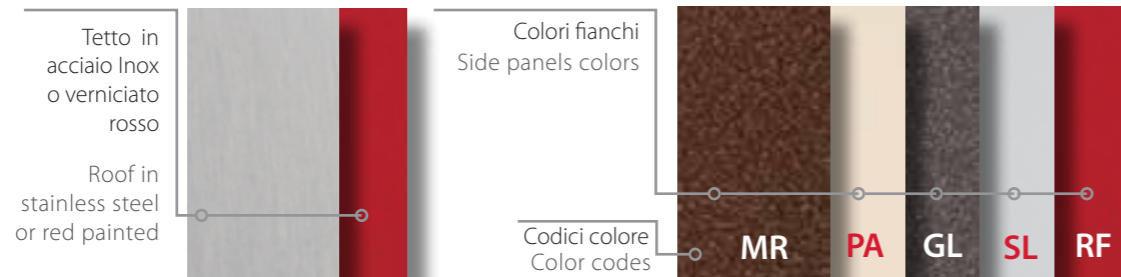

## DOTAZIONI DI SERIE

Carrello, ventilazione, valvole fumi e vapori, termometro, timer, illuminazione interna, 2 griglie cromate, 2 teglie, accessorio prenditeglie, attizzatoio, comignolo antivento, guanto e presina.

## STANDARD EQUIPMENT

Cart, ventilation fan, smoke and steam valves, thermometer, timer, internal lighting, 2 chrome grilles, 2 baking pans, pan holder tool, poker, windproof chimney, oven mitt and pan holder.

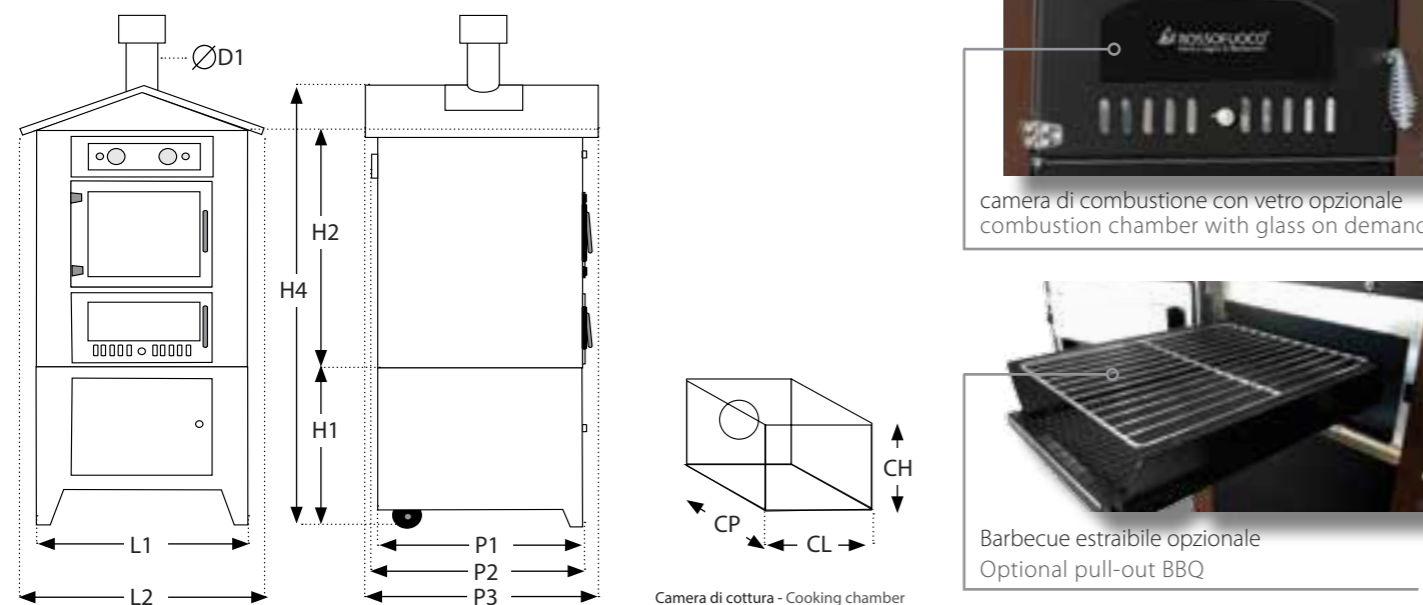

| Codice modello<br>Item code   | L1  | L2   | P1  | P2  | P3   | H1  | H2  | H4   | KG  | D1  | CL  | CP  | CH  | Carica legna<br>Wood load | Prezzo<br>Price |
|---|-----|------|-----|-----|------|-----|-----|------|-----|-----|-----|-----|-----|---------------------------|-----------------|
| GAC80CM-<br>Struttura Marrone+tetto Rosso<br>Body Brown+Red roof    | 805 | 1060 | 930 | 970 | 1180 | 650 | 980 | 1770 | 266 | 130 | 480 | 800 | 420 | 3/4 kg                    |                 |
| GAC80CG-<br>Struttura Grigio L. +tetto Rosso<br>Body Brown+Red roof |     |      |     |     |      |     |     |      |     |     |     |     |     |                           |                 |

Dimensioni in millimetri, peso in Kg. - Dimensions in millimeters, weight in Kg.

Prezzi Iva esclusa / Prices are VAT or Taxes excluded

| Codice aggiuntivo per colore dei fianchi<br>Additional code for color of sides | GL                       | MR               | SL                           | RF           | PA             |
|--|--------------------------|------------------|------------------------------|--------------|----------------|
|  | Grigio Lava<br>Lava Grey | Marrone<br>Brown | Grigio Silver<br>Silver Grey | Rosso<br>Red | Panna<br>cream |

| Listino accessori / Accessories price list                      |  | Iva esclusa / VAT or Taxes excluded                         |                                     |
|---|--|---|-------------------------------------|
| Per<br>For  | Barbecue estraibile<br>Pull-out Barbecue | Piana refrattaria aggiuntiva<br>Additional refractory plate | Kit Porchetta<br>Kit for big roasts |
| Garden Color 80   | BCF                                      | PB80  | GP80KIT                             |
| Supplemento per tetto inox / Surcharge for stainless steel roof |  |   | TX80                                |
| Vetro su camera di combustione / Glass on combustion chamber    |  |   | GAVTCC                              |
| Piano di lavoro laterale / Side work top                        |  |   | PA80/100                            |

Trovi altri accessori a pagina 86:  
barbecue laterale Falò  
mensola frontale,  
pale pane pizza,  
porta pale,  
griglie e teglie aggiuntive,  
cappottine....

More accessories at page 86:  
side barbecue Falò  
front shelf,  
bread and pizza shovels,  
shovel holder,  
additional grilles and pans,  
waterproof cover....

# FORNI A COMBUSTIONE SEPARATA DA ESTERNO

## OUTDOOR SEPARATED COMBUSTION OVENS

Garden Color

Combinazione colori personalizzabile tra frontale, fianchi, tetto - Carrello separato dal corpo del forno.  
Customizable colors combination of front, sides, roof - Cart separated from the body of the oven.





# Eco & Eco 50

la semplicità che dona grandi soddisfazioni

the simplicity that gives great satisfaction

**5** anni di Garanzia  
su camere di cottura e combustione  
on baking and cooking chambers  
years warranty

**100%** Made  
in Italy



## DOTAZIONI DI SERIE

**Eco:** Carrello, ventilazione, valvole fumi e vapori, termometro, timer, illuminazione interna, 3 griglie cromate, 1 teglia rettangolare, 2 teglie rotonde, accessorio prenditeglie, attizzatoio, comignolo antivento, guanto e presina.

**Eco 50:** Carrello, ventilazione, termometro, timer, illuminazione interna, 2 griglie cromate, 2 teglie, accessorio prenditeglie, attizzatoio, comignolo antivento, guanto e presina.

## STANDARD EQUIPMENT

**Eco:** Cart, ventilation fan, smoke and steam valves, thermometer, timer, internal lighting, 3 chrome grilles, 1 rectangular baking pan, 2 round baking pans, pan holder tool, poker, windproof chimney, oven mitt and pan holder.

**Eco 50:** Cart, ventilation fan, thermometer, timer, internal lighting, 2 chrome grilles, 2 baking pans, pan holder tool, poker, windproof chimney, oven mitt and pan holder.

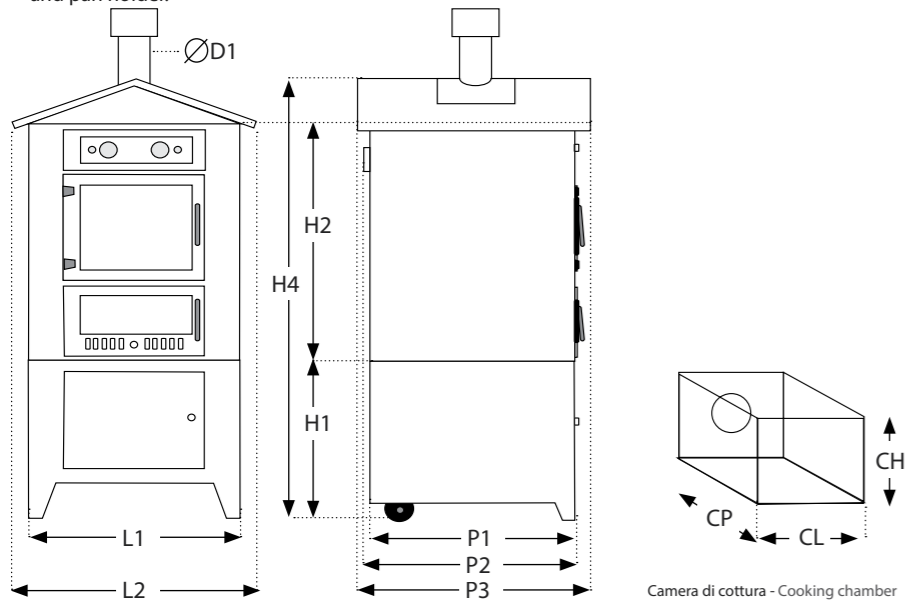

Camera di cottura - Cooking chamber

| Codice modello<br>Item code | L1  | L2   | P1   | P2   | P3   | H1  | H2  | H4   | KG  | D1  | CL  | CP   | CH  | Carica legna<br>Wood load | Prezzo<br>Price |
|-----------------------------|-----|------|------|------|------|-----|-----|------|-----|-----|-----|------|-----|---------------------------|-----------------|
| Eco 65-CC                   | 755 | 1000 | 775  | 815  | 1050 | 650 | 980 | 1770 | 229 | 130 | 480 | 650  | 420 | 3 kg.                     |                 |
| Eco 80-CC                   | 805 | 1060 | 930  | 970  | 1180 | 650 | 980 | 1770 | 266 | 130 | 480 | 800  | 420 | 3/4 kg                    |                 |
| Eco 100-CC                  | 805 | 1060 | 1120 | 1160 | 1380 | 650 | 980 | 1770 | 320 | 130 | 480 | 1000 | 420 | 4 kg.                     |                 |
| Eco 50-CC                   | 615 | 840  | 650  | 690  | 890  | 715 | 850 | 1745 | 150 | 130 | 400 | 500  | 400 | 3 kg.                     |                 |

Dimensioni in millimetri, peso in Kg. - Dimensions in millimeters, weight in Kg.

Prezzi Iva esclusa / Prices are VAT or Taxes excluded

| Listino accessori / Accessories price list   |  |                                 |                                     | Iva esclusa / VAT or Taxes excluded |  |
|--|--|---------------------------------|-------------------------------------|-------------------------------------|--|
| Per<br>For   | Barbecue laterale "Falò"<br>Side barbecue "Falò" | Piano laterale<br>Side work top | Kit Porchetta<br>Kit for big roasts |                                     |  |
| Eco 65-CC  | BEF  | PA 65                           | GP65KIT                             |                                     |  |
| Eco 80-CC  | BEF  | PA 80/100                       | GP80KIT                             |                                     |  |
| Eco 100-CC   | BEF  | PA 80/100                       | GP100KIT                            |                                     |  |
| Eco 50-CC  | Non disp./Not available                          | PA 50                           | Non disp./Not available             |                                     |  |
| Supplemento per tetto Inox forni da 65/80/100<br>Surcharge for roof in stainless steel ovens 65/80/100 |  |                                 |                                     | TX **                               |  |

Trovi altri accessori  
a pagina 86:  
mensola frontale,  
piastra refrattaria aggiuntiva,  
pale pane pizza,  
porta pale,  
griglie e teglie aggiuntive,  
cappottine....

More accessories  
at page 86:  
front shelf,  
additional refractory plate,  
bread and pizza shovels,  
shovel holder,  
additional grilles and pans,  
waterproof cover....

# FORNI A COMBUSTIONE SEPARATA DA ESTERNO

OUTDOOR SEPARATED COMBUSTION OVENS

# Eco & Eco 50



Struttura verniciata - Tetto verniciato rosso - Eco 50 ha dimensioni più compatte.

Body painted - Red painted roof - Eco 50 has a smaller size.



Eco  
65/80/100



Eco 50

**FORNI A COMBUSTIONE SEPARATA  
DA INCASSO**

---

**BUILT IN  
SEPARATED COMBUSTION OVENS**

|                                  |       |
|----------------------------------|-------|
| Sedicioni Inox - black - country | 34-39 |
| Steel                            | 44-41 |
| Fiamma                           | 42-43 |
| Rame                             | 42-43 |
| Red                              | 44-45 |
| Effe                             | 46-47 |
| Eco                              | 48-49 |
| Eco 50                           | 48-49 |
| Garden color                     | 50-51 |
| Quattrostagioni                  | 52-53 |

# Sedicinoni Inox

la praticità della camera di cottura orizzontale

great ease with the ultra-wide cooking chamber



**5** anni di Garanzia  
su camera di cottura e combustione  
on baking and cooking chambers  
years warranty

**100%** Made  
in Italy

## DOTAZIONI DI SERIE

**Doppia ventilazione**, valvole fumi e vapori, termometro, timer, illuminazione interna, 3 griglie cromate, 2 teglie rettangolari, accessorio prenditeglie, attizzatoio, guanto e presina.

## STANDARD EQUIPMENT

**Double ventilation fan**, smoke and steam valves, thermometer, timer, internal lighting, 3 chrome grilles, 2 rectangular baking pans, pan holder tool, poker, oven mitt and pan holder.

Vista frontale - View from the front

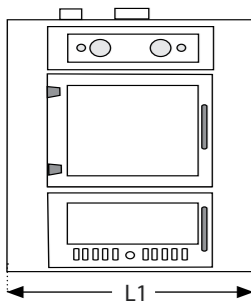

Vista laterale - View from the side

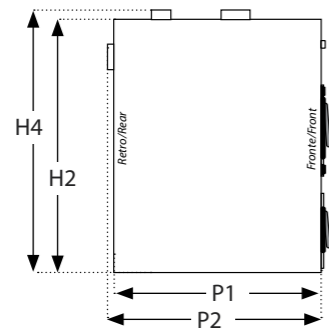

Vista dall'alto - View from the top

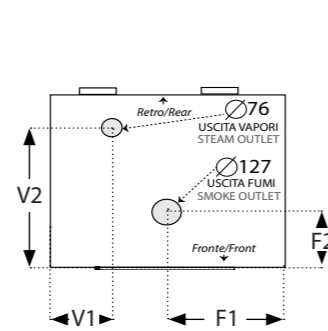

Camera di cottura - Cooking chamber

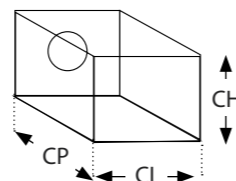

| Codice modello<br>Item code | L1   | P1  | P2  | H2   | H4   | F1  | F2  | V1  | V2  | KG  | CL  | CP  | CH  | Carica legna<br>Wood load | Prezzo<br>Price |
|-----------------------------|------|-----|-----|------|------|-----|-----|-----|-----|-----|-----|-----|-----|---------------------------|-----------------|
| Sedicinoni 80iA             | 1005 | 780 | 820 | 1000 | 1040 | 502 | 270 | 335 | 640 | 200 | 730 | 630 | 390 | 3/4 Kg.                   |                 |

Dimensioni in millimetri, peso in Kg. - Dimensions in millimeters, weight in Kg. Prezzi Iva esclusa / Prices are VAT or Taxes excluded

| Listino accessori / Accessories price list                 |             | Iva esclusa / VAT or Taxes excluded |  |
|--|-------------|-------------------------------------|--|
| Articolo / Item  | Codice Code | Prezzo Price                        |  |
| Supporto fisso per forno / Special stand for oven          | SW          |                                     |  |
| Kit Porchetta / Kit for big roasts                         | GPWKIT      |                                     |  |
| Piana refrattaria aggiuntiva / Additional refractory plate | PBWSC       |                                     |  |

Trovi altri accessori a pagina 86: teglie speciali, pala pane pizza, porta pale, griglie e teglie aggiuntive...

More accessories at page 86: special pans, bread and pizza shovels, shovel holder additional grilles and pans...

# FORNI A COMBUSTIONE SEPARATA DA INCASSO

BUILT IN SEPARATED COMBUSTION OVENS

# Sedicinoni Inox



Finiture in acciaio Inox - Camera di cottura sviluppata orizzontalmente - Camere di cottura e combustione con vetri a specchio.  
Stainless steel front panels - Stainless steel roof - Horizontal layout of the cooking chamber - Doors with mirrored glass.



Gli accessori più richiesti

The most popular accessories



Piana refrattaria aggiuntiva  
Additional refractory plate



Kit "Porchetta"



Pala/ Shovel



Portapala / Shovels kit

# Sedicinoni Black

tutto in vista con la camera di cottura orizzontale

great ease with the ultra-wide cooking chamber



**5** anni di Garanzia  
su camera di cottura e combustione  
on baking and cooking chambers  
years warranty

**100%** Made  
in Italy

## DOTAZIONI DI SERIE

**Doppia ventilazione**, valvole fumi e vapori, termometro, timer, illuminazione interna, 3 griglie cromate, 2 teglie rettangolari, accessorio prenditeglie, attizzatoio, guanto e presina.

## STANDARD EQUIPMENT

**Double ventilation fan**, smoke and steam valves, thermometer, timer, internal lighting, 3 chrome grilles, 2 rectangular baking pans, pan holder tool, poker, oven mitt and pan holder.

Vista frontale - View from the front

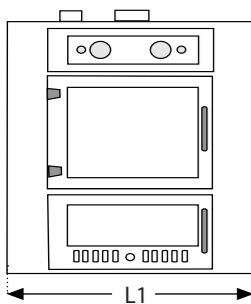

Vista laterale - View from the side

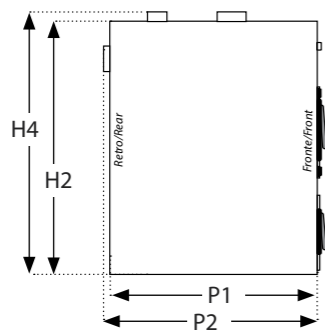

Vista dall'alto - View from the top

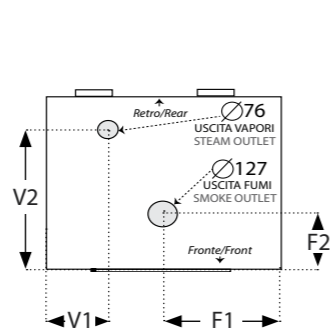

Camera di cottura - Cooking chamber

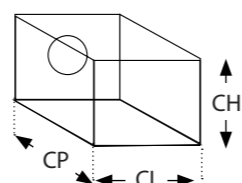

| Codice modello<br>Item code | L1   | P1  | P2  | H2   | H4   | F1  | F2  | V1  | V2  | KG  | CL  | CP  | CH  | Carica legna<br>Wood load | Prezzo<br>Price |
|-----------------------------|------|-----|-----|------|------|-----|-----|-----|-----|-----|-----|-----|-----|---------------------------|-----------------|
| Sedicinoni 80iB             | 1005 | 780 | 820 | 1000 | 1040 | 502 | 270 | 335 | 640 | 200 | 730 | 630 | 390 | 3/4 Kg.                   |                 |

Dimensioni in millimetri, peso in Kg. - Dimensions in millimeters, weight in Kg. Prezzi Iva esclusa / Prices are VAT or Taxes excluded

| Listino accessori / Accessories price list                 |             | Iva esclusa / VAT or Taxes excluded |  |
|--|-------------|-------------------------------------|--|
| Articolo / Item  | Codice Code | Prezzo Price                        |  |
| Supporto fisso per forno / Special stand for oven          | SW          |                                     |  |
| Kit Porchetta / Kit for big roasts                         | GPWKIT      |                                     |  |
| Piana refrattaria aggiuntiva / Additional refractory plate | PBWSC       |                                     |  |

Trovi altri accessori  
a pagina 86:  
teglie speciali  
pale pane pizza,  
porta pale,  
griglie e teglie aggiuntive...

More accessories  
at page 86:  
special pans,  
bread and pizza shovels,  
shovel holder  
additional grilles and pans...

# FORNI A COMBUSTIONE SEPARATA DA INCASSO

BUILT IN SEPARATED COMBUSTION OVENS

# Sedicinoni Black



Verniciato nero - Camera di cottura sviluppata orizzontalmente - Doppia ventilazione.  
Black painted - Horizontal layout of the cooking chamber - Double ventilation fan.



Gli accessori  
più richiesti

The most popular  
accessories



Piana refrattaria aggiuntiva  
Additional refractory plate



Kit "Porchetta"



Pala/ Shovel



Set pale / Shovels kit

# Sedicinoni Country

la praticità della camera di cottura orizzontale

great ease with the ultra-wide cooking chamber



**5** anni di Garanzia  
su camera di cottura e combustione  
on baking and cooking chambers  
years warranty

**100%** Made  
in Italy

## DOTAZIONI DI SERIE

**Doppia ventilazione**, valvole fumi e vapori, termometro, timer, illuminazione interna, 3 griglie cromate, 2 teglie rettangolari, accessorio prenditeglie, attizzatoio, guanto e presina.

## STANDARD EQUIPMENT

**Double ventilation fan**, smoke and steam valves, thermometer, timer, internal lighting, 3 chrome grilles, 2 rectangular baking pans, pan holder tool, poker, oven mitt and pan holder.

Vista frontale - View from the front

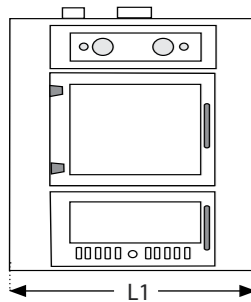

Vista laterale - View from the side

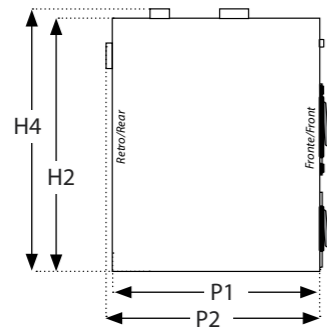

Vista dall'alto - View from the top

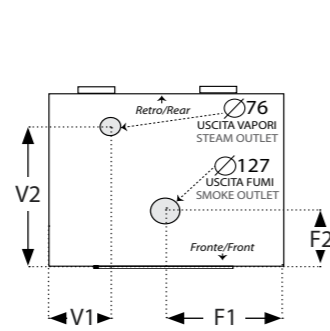

Camera di cottura - Cooking chamber

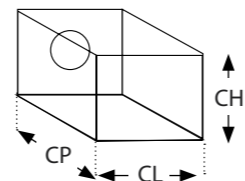

| Codice modello<br>Item code | L1   | P1  | P2  | H2   | H4   | F1  | F2  | V1  | V2  | KG  | CL  | CP  | CH  | Carica legna<br>Wood load | Prezzo<br>Price |
|-----------------------------|------|-----|-----|------|------|-----|-----|-----|-----|-----|-----|-----|-----|---------------------------|-----------------|
| Sedicinoni 80iC             | 1005 | 780 | 820 | 1000 | 1040 | 502 | 270 | 335 | 640 | 200 | 730 | 630 | 390 | 3/4 Kg.                   |                 |

Dimensioni in millimetri, peso in Kg. - Dimensions in millimeters, weight in Kg.      Prezzi Iva esclusa / Prices are VAT or Taxes excluded

| Listino accessori / Accessories price list                 |             | Iva esclusa / VAT or Taxes excluded |  |
|--|-------------|-------------------------------------|--|
| Articolo / Item  | Codice Code | Prezzo Price                        |  |
| Supporto fisso per forno / Special stand for oven          | SW          |                                     |  |
| Kit Porchetta / Kit for big roasts                         | GPWKIT      |                                     |  |
| Piana refrattaria aggiuntiva / Additional refractory plate | PBWSC       |                                     |  |

Trovi altri accessori  
a pagina 86:  
teglie speciali  
pale pane pizza,  
porta pale,  
griglie e teglie aggiuntive...

More accessories  
at page 86:  
special pans,  
bread and pizza shovels,  
shovel holder  
additional grilles and pans...

# FORNI A COMBUSTIONE SEPARATA DA INCASSO

BUILT IN SEPARATED COMBUSTION OVENS

# Sedicinoni Country



Verniciato marrone - Camera di cottura sviluppata orizzontalmente - Doppia ventilazione .  
Brown painted - Horizontal layout of the cooking chamber - Double ventilation fan.



Gli accessori  
più richiesti

The most popular  
accessories



Piana refrattaria aggiuntiva  
Additional refractory plate



Kit "Porchetta"



Pala/Shovel



Set pale / Shovels kit

# Steel

la forza e la bellezza dell'acciaio

the strenght and the beauty of steel

**5** anni di Garanzia  
su camere di cottura e combustione  
on baking and cooking chambers  
years warranty

**100%** Made  
in Italy



## DOTAZIONI DI SERIE

Ventilazione, valvole fumi e vapori, termometro, timer, illuminazione interna, 3 griglie cromate, 1 teglia rettangolare, 2 teglie rotonde, accessorio prenditeglie, attizzatoio, guanto e presina.

## STANDARD EQUIPMENT

Ventilation fan, smoke and steam valves, thermometer, timer, internal lighting, 3 chrome grilles, 1 rectangular baking pan, 2 round baking pans, pan holder tool, poker, oven mitt and pan holder.

Vista frontale - View from the front

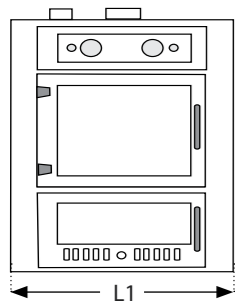

Vista laterale - View from the side

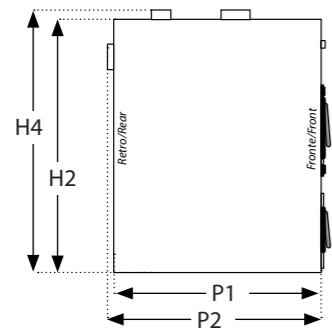

Vista dall'alto - View from the top

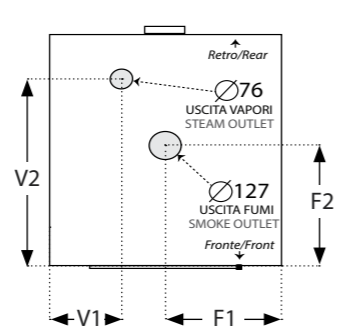

Camera di cottura - Cooking chamber

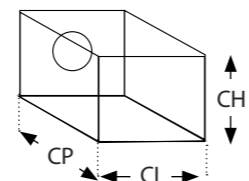

| Codice modello<br>Item code | L1  | P1   | P2   | H2  | H4   | F1  | F2  | V1  | V2   | KG  | CL  | CP   | CH  | Carica legna<br>Wood load | Prezzo<br>Price |
|-----------------------------|-----|------|------|-----|------|-----|-----|-----|------|-----|-----|------|-----|---------------------------|-----------------|
| Steel 65i                   | 755 | 775  | 815  | 980 | 1010 | 377 | 425 | 215 | 655  | 173 | 480 | 650  | 420 | 3 KG                      |                 |
| Steel 80i                   | 805 | 930  | 970  | 980 | 1010 | 402 | 425 | 245 | 810  | 200 | 480 | 800  | 420 | 3/4 kg                    |                 |
| Steel 100i                  | 805 | 1120 | 1160 | 980 | 1010 | 402 | 525 | 245 | 1005 | 248 | 480 | 1000 | 420 | 4 kg                      |                 |

Dimensioni in millimetri, peso in Kg. - Dimensions in millimeters, weight in Kg.

Prezzi Iva esclusa / Prices are VAT or Taxes excluded

| Listino accessori / Accessories price list |                                 | Iva esclusa / VAT or Taxes excluded |   |
|--|---------------------------------|-------------------------------------|---|
| Per For                                    | Supporto fisso<br>Special stand | Kit Porchetta<br>Kit for big roasts | Piana refrattaria agg.<br>Addit. refractory plate |
| Steel 65i                                  | S65                             | GP65KIT                             | PB65  |
| Steel 80i                                  | S80                             | GP80KIT                             | PB80  |
| Steel 100i                                 | S100                            | GP100KIT                            | PB100   |

Trovi altri accessori a pagina 86:  
mensolina frontale, teglie speciali, pale pane pizza, porta pale, griglie e teglie aggiuntive...

More accessories at page 86:  
front shelf, special pans, bread and pizza shovels, shovel holder additional grilles and pans...

# FORNI A COMBUSTIONE SEPARATA DA INCASSO

BUILT IN SEPARATED COMBUSTION OVENS

Steel



Struttura frontale acciaio inox - Vetri a specchio nelle camere di cottura e combustione.  
Stainless steel front panel - Doors with mirrored glasses.



Gli accessori più richiesti

The most popular accessories



Piana refrattaria aggiuntiva  
Additional refractory plate



Kit "Porchetta"



Teglia forata/ Perforated pan



Pala/ Shovel



Colore mod. Fiamma  
Color mod. Fiamma

Colore mod. Rame  
Color mod. Rame

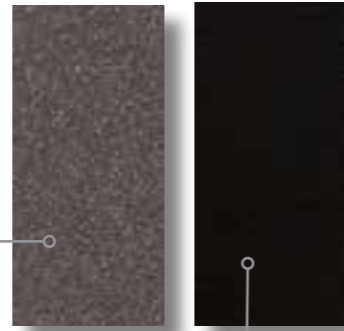

## DOTAZIONI DI SERIE

Ventilazione, valvole fumi e vapori, termometro, timer, illuminazione interna, 3 griglie cromate, 1 teglia rettangolare, 2 teglie rotonde, accessorio prenditeglie, attizzatoio, guanto e presina.

## STANDARD EQUIPMENT

Ventilation fan, smoke and steam valves, thermometer, timer, internal lighting, 3 chrome grilles, 1 rectangular baking pan, 2 round baking pans, pan holder tool, poker, oven mitt and pan holder.

**5** anni di Garanzia  
su camere di cottura e combustione  
on baking and cooking chambers  
years warranty

**100%** Made  
in Italy

Vista frontale - View from the front

Vista laterale - View from the side

Vista dall'alto - View from the top

Camera di cottura - Cooking chamber

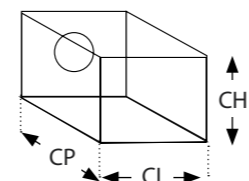
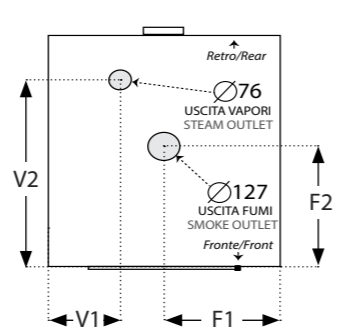
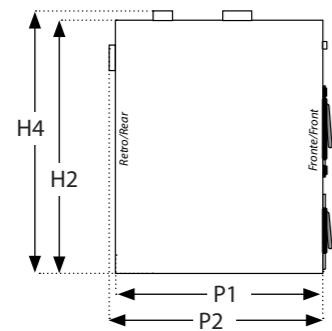
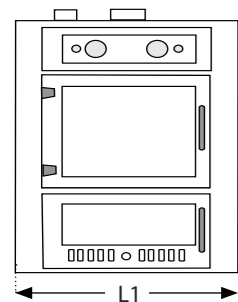

| Codice modello<br>Item code | L1  | P1   | P2   | H2  | H4   | F1  | F2  | V1  | V2   | KG  | CL  | CP   | CH  | Carica legna<br>Wood load | Prezzo<br>Price |
|-----------------------------|-----|------|------|-----|------|-----|-----|-----|------|-----|-----|------|-----|---------------------------|-----------------|
| Fiamma 65i / Rame 65i       | 755 | 775  | 815  | 980 | 1010 | 377 | 425 | 215 | 655  | 173 | 480 | 650  | 420 | 3 KG                      |                 |
| Fiamma 80i / Rame 80i       | 805 | 930  | 970  | 980 | 1010 | 402 | 425 | 245 | 810  | 200 | 480 | 800  | 420 | 3/4 kg                    |                 |
| Fiamma 100i / Rame 100i     | 805 | 1120 | 1160 | 980 | 1010 | 402 | 525 | 245 | 1005 | 248 | 480 | 1000 | 420 | 4 kg                      |                 |

Dimensioni in millimetri, peso in Kg. - Dimensions in millimeters, weight in Kg.

Prezzi Iva esclusa / Prices are VAT or Taxes excluded

## Listino accessori / Accessories price list

| Per<br>For       | Supporto fisso<br>Special stand | Kit Porchetta<br>Kit for big roasts | Piana refrattaria agg.<br>Addit. refractory plate |
|------------------|---------------------------------|-------------------------------------|---|
| Fiamma/Rame 65i  | S65                             | GP65KIT                             | PB65  |
| Fiamma/Rame 80i  | S80                             | GP80KIT                             | PB80  |
| Fiamma/Rame 100i | S100                            | GP100KIT                            | PB100   |

Trovi altri accessori  
a pagina 86:  
mensolina frontale,  
teglie speciali  
pale pane pizza,  
porta pale,  
griglie e teglie aggiuntive...

More accessories  
at page 86:  
front shelf,  
special pans,  
bread and pizza shovels,  
shovel holder  
additional grilles and pans...



Struttura verniciata - Fiamma: grigio e intarsi acciaio inox; Rame: nero e intarsi rame - Vetro anche nella camera di combustione.  
Fiamma: painted grey and stainless steel finishes; Rame: painted black and copper finishes - Glass also in the combustion chamber.



Gli accessori  
più richiesti

The most popular  
accessories



Piana refrattaria aggiuntiva  
Additional refractory plate



Kit "Porchetta"



Teglia forata/ Perforated pan



Pala/ Shovel

Red

più bello più rosso del fuoco

more beautiful more red than fire



**5** anni di Garanzia  
su camera di cottura e combustione  
on baking and cooking chambers  
years warranty

**100%** Made  
in Italy

### DOTAZIONI DI SERIE

Ventilazione, valvole fumi e vapori, termometro, timer, illuminazione interna, 3 griglie cromate, 1 teglia rettangolare, 2 teglie rotonde, accessorio prenditeglie, attizzatoio, guanto e presina.

### STANDARD EQUIPMENT

Ventilation fan, smoke and steam valves, thermometer, timer, internal lighting, 3 chrome grilles, 1 rectangular baking pan, 2 round baking pans, pan holder tool, poker, oven mitt and pan holder.

Vista frontale - View from the front

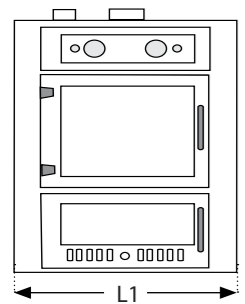

Vista laterale - View from the side

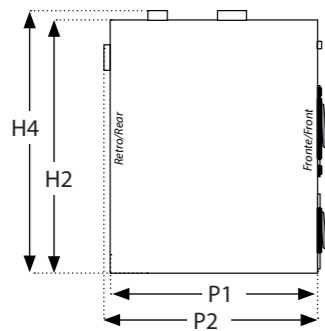

Vista dall'alto - View from the top

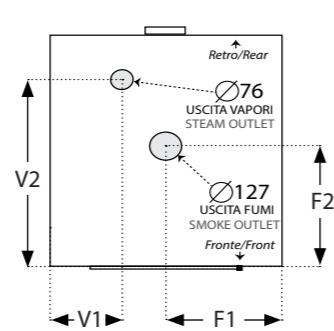

Camera di cottura - Cooking chamber

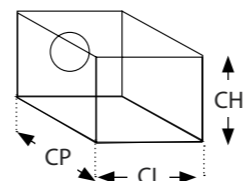

| Codice modello<br>Item code | L1  | P1   | P2   | H2  | H4   | F1  | F2  | V1  | V2   | KG  | CL  | CP   | CH  | Carica legna<br>Wood load | Prezzo<br>Price |
|-----------------------------|-----|------|------|-----|------|-----|-----|-----|------|-----|-----|------|-----|---------------------------|-----------------|
| Red 65i                     | 755 | 775  | 815  | 980 | 1010 | 377 | 425 | 215 | 655  | 173 | 480 | 650  | 420 | 3 KG                      |                 |
| Red 80i                     | 805 | 930  | 970  | 980 | 1010 | 402 | 425 | 245 | 810  | 200 | 480 | 800  | 420 | 3/4 kg                    |                 |
| Red100i                     | 805 | 1120 | 1160 | 980 | 1010 | 402 | 525 | 245 | 1005 | 248 | 480 | 1000 | 420 | 4 kg                      |                 |

Dimensioni in millimetri, peso in Kg. - Dimensions in millimeters, weight in Kg.

Prezzi Iva esclusa / Prices are VAT or Taxes excluded

### Listino accessori / Accessories price list Iva esclusa / VAT or Taxes excluded

| Per For  | Supporto fisso<br>Special stand | Kit Porchetta<br>Kit for big roasts | Piana refrattaria agg.<br>Addit. refractory plate |
|----------|---------------------------------|-------------------------------------|---|
| Red 65i  | S65                             | GP65KIT                             | PB65  |
| Red 80i  | S80                             | GP80KIT                             | PB80  |
| Red 100i | S100                            | GP100KIT                            | PB100   |

Trovi altri accessori a pagina 86: mensolina frontale, teglie speciali, pale pane pizza, porta pale, griglie e teglie aggiuntive...

More accessories at page 86: front shelf, special pans, bread and pizza shovels, shovel holder additional grilles and pans...

## FORNI A COMBUSTIONE SEPARATA DA INCASSO

BUILT IN SEPARATED COMBUSTION OVENS

Red



Struttura verniciata - intarsi in acciaio inox - Vetro anche nella camera di combustione.  
Body painted red - Stainless steel finishes - Glass also in the combustion chamber.



Gli accessori più richiesti

The most popular accessories



Piana refrattaria aggiuntiva  
Additional refractory plate



Kit "Porchetta"



Teglia forata/ Perforated pan



Pala/ Shovel





**5** anni di Garanzia  
su camere di cottura e combustione  
on baking and cooking chambers  
years warranty

**100%** Made  
in Italy

**DOTAZIONI DI SERIE**

Ventilazione, valvole fumi e vapori, termometro, timer, illuminazione interna, 3 griglie cromate, 1 teglia rettangolare, 2 teglie rotonde, accessorio prenditeghe, attizzatoio, guanto e presina.

**STANDARD EQUIPMENT**

Ventilation fan, smoke and steam valves, thermometer, timer, internal lighting, 3 chrome grilles, 1 rectangular baking pan, 2 round baking pans, pan holder tool, poker, oven mitt and pan holder.

Vista frontale - View from the front

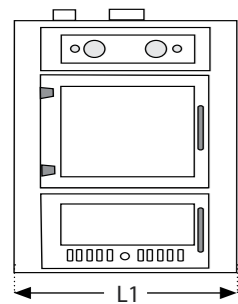

Vista laterale - View from the side

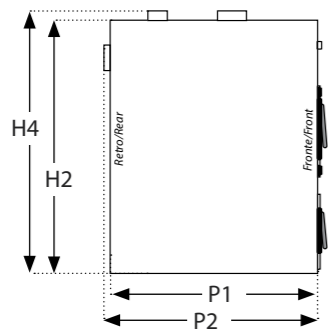

Vista dall'alto - View from the top

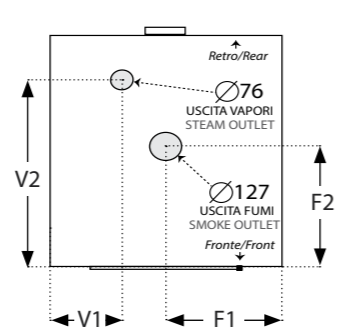

Camera di cottura - Cooking chamber

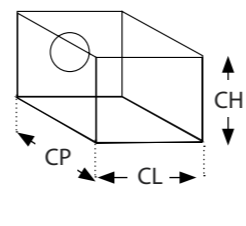

| Codice modello<br>Item code | L1  | P1   | P2   | H2  | H4   | F1  | F2  | V1  | V2   | KG  | CL  | CP   | CH  | Carica legna<br>Wood load | Prezzo<br>Price |
|-----------------------------|-----|------|------|-----|------|-----|-----|-----|------|-----|-----|------|-----|---------------------------|-----------------|
| Effe 65i                    | 755 | 775  | 815  | 980 | 1010 | 377 | 425 | 215 | 655  | 173 | 480 | 650  | 420 | 3 KG                      |                 |
| Effe 80i                    | 805 | 930  | 970  | 980 | 1010 | 402 | 425 | 245 | 810  | 200 | 480 | 800  | 420 | 3/4 kg                    |                 |
| Effe100i                    | 805 | 1120 | 1160 | 980 | 1010 | 402 | 525 | 245 | 1005 | 248 | 480 | 1000 | 420 | 4 kg                      |                 |

Dimensioni in millimetri, peso in Kg. - Dimensions in millimeters, weight in Kg.

Prezzi Iva esclusa / Prices are VAT or Taxes excluded

| Listino accessori / Accessories price list |                                 | Iva esclusa / VAT or Taxes excluded |   |  |  |
|--|---------------------------------|-------------------------------------|---|--|--|
| Per For                                    | Supporto fisso<br>Special stand | Kit Porchetta<br>Kit for big roasts | Piana refrattaria agg.<br>Addit. refractory plate |  |  |
| Effe 65i                                   | S65                             | GP65KIT                             | PB65  |  |  |
| Effe 80i                                   | S80                             | GP80KIT                             | PB80  |  |  |
| Effe 100i                                  | S100                            | GP100KIT                            | PB100   |  |  |

Trovi altri accessori a pagina 86: mensolina frontale, teglie speciali, pale pane pizza, porta pale, griglie e teglie aggiuntive...

More accessories at page 86: front shelf, special pans, bread and pizza shovels, shovel holder additional grilles and pans...

Struttura verniciata - Bordatura vetri in acciaio inox - Consolle strumenti con ribaltina di protezione.  
Painted - Glasses with steel frame - Control panel protected by tilting lid.



Gli accessori più richiesti

The most popular accessories



Piana refrattaria aggiuntiva  
Additional refractory plate



Kit "Porchetta"



Teglia forata/ Perforated pan



Pala/ Shovel

# Eco & Eco 50

design essenziale, alta qualità, costo contenuto

minimal design, high quality, low cost

**5** anni di Garanzia  
su camera di cottura e combustione  
on baking and cooking chambers  
years warranty

**100%** Made  
in Italy



## DOTAZIONI DI SERIE

**Eco:** Ventilazione, valvole fumi e vapori, termometro, timer, illuminazione interna, 3 griglie cromate, 1 teglia rettangolare, 2 teglie rotonde, accessorio prenditeglie, attizzatoio, guanto e presina.

**Eco 50:** Ventilazione, termometro, timer, illuminazione interna, 2 griglie cromate, 2 teglie, accessorio prenditeglie, attizzatoio, guanto e presina.

## STANDARD EQUIPMENT

**Eco:** Ventilation fan, smoke and steam valves, thermometer, timer, internal lighting, 3 chrome grilles, 1 rectangular baking pan, 2 round baking pans, pan holder tool, poker, oven mitt and pan holder.

**Eco 50:** Ventilation fan, thermometer, timer, internal lighting, 2 chrome grilles, 2 baking pans, pan holder tool, poker, oven mitt and pan holder.

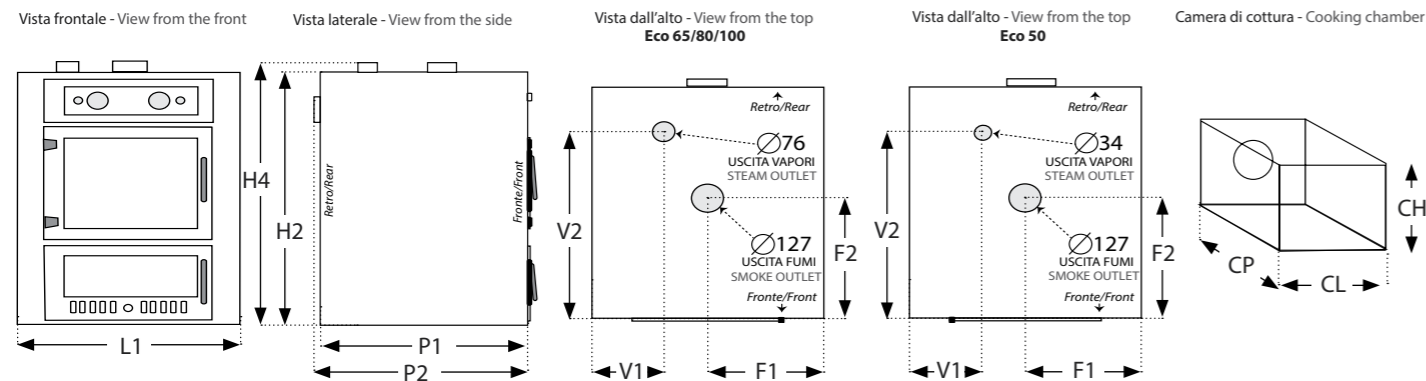

| Codice modello<br>Item code | L1  | P1   | P2   | H2  | H4   | F1  | F2  | V1  | V2   | KG  | CL  | CP   | CH  | Carica legna<br>Wood load | Prezzo<br>Price |
|-----------------------------|-----|------|------|-----|------|-----|-----|-----|------|-----|-----|------|-----|---------------------------|-----------------|
| Eco 65i                     | 755 | 775  | 815  | 980 | 1010 | 377 | 425 | 215 | 655  | 173 | 480 | 650  | 420 | 3 kg                      |                 |
| Eco 80i                     | 805 | 930  | 970  | 980 | 1010 | 402 | 425 | 245 | 810  | 200 | 480 | 800  | 420 | 3/4 kg                    |                 |
| Eco 100i                    | 805 | 1120 | 1160 | 980 | 1010 | 402 | 525 | 245 | 1005 | 248 | 480 | 1000 | 420 | 4 kg                      |                 |
| Eco 50i                     | 615 | 650  | 690  | 850 | 890  | 307 | 280 | 185 | 495  | 110 | 400 | 500  | 400 | 3 Kg                      |                 |

Dimensioni in millimetri, peso in Kg. - Dimensions in millimeters, weight in Kg. Prezzi Iva esclusa / Prices are VAT or Taxes excluded

| Listino accessori / Accessories price list |                                 | Iva esclusa / VAT or Taxes excluded |   |
|--|---------------------------------|-------------------------------------|---|
| Per For                                    | Supporto fisso<br>Special stand | Kit Porchetta<br>Kit for big roasts | Piana refrattaria agg.<br>Addit. refractory plate |
| Eco 65i                                    | S65                             | GP65KIT                             | PB65  |
| Eco 80i                                    | S80                             | GP80KIT                             | PB80  |
| Eco 100i                                   | S100                            | GP100KIT                            | PB100   |
| Eco 50i                                    | S50                             | Non disp./Not availab.              | PB50  |

Trovi altri accessori a pagina 86: mensolina frontale (\*), teglie speciali, pale pane pizza, porta pale, griglie e teglie aggiuntive...

(\* escluso Eco 50

More accessories at page 86: front shelf (\*), special pans, bread and pizza shovels, shovel holder additional grilles and pans...

(\*) except Eco 50

# FORNI A COMBUSTIONE SEPARATA DA INCASSO

BUILT IN SEPARATED COMBUSTION OVENS

# Eco & Eco 50



Struttura verniciata - Consolle strumenti completa - vetro anche sulla camera di combustione.

Painted - complete instrument console - glass also on the combustion chamber.



Eco 65/80/100

Eco 50

Gli accessori più richiesti

The most popular accessories



Piana refrattaria aggiuntiva  
Additional refractory plate



Kit "Porchetta"



Teglia forata/ Perforated pan



Pala/ Shovel

**5** anni di Garanzia  
su camera di cottura e combustione  
on baking and cooking chambers  
years warranty

**100%** Made  
in Italy



camera di combustione con vetro opzionale  
combustion chamber with glass on demand

Colori del frontale  
Front panel colors

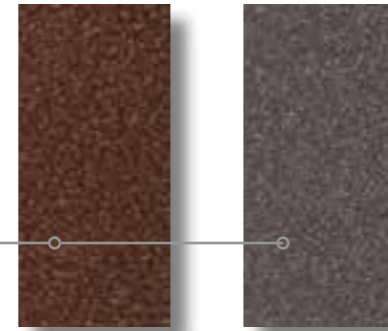

Codici colore  
Color codes

**MR**

**GL**

## DOTAZIONI DI SERIE

Ventilazione, valvole fumi e vapori, termometro, timer, illuminazione interna, 2 griglie cromate, 2 teglie, accessorio prenditeglie, attizzatoio, guanto e presina.

## STANDARD EQUIPMENT

Ventilation fan, smoke and steam valves, thermometer, timer, internal lighting, 2 chrome grilles, 2 baking pans, pan holder tool, poker, oven mitt and pan holder.

Vista frontale - View from the front

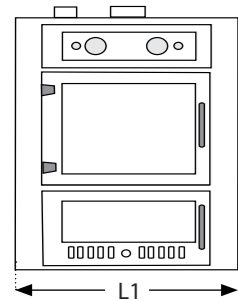

Vista laterale - View from the side

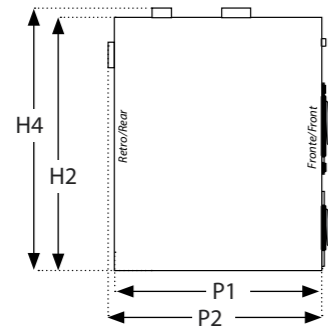

Vista dall'alto - View from the top

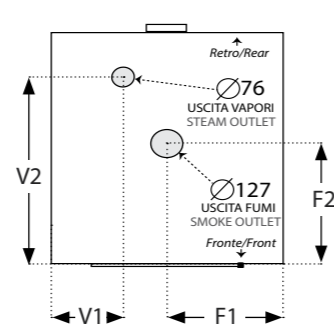

Camera di cottura - Cooking chamber

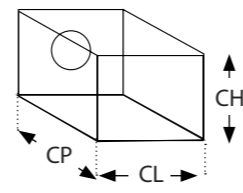

| Codice modello<br>Item code | Colore<br>Color          | L1  | P1  | P2  | H2  | H4   | F1  | F2  | V1  | V2  | KG  | CL  | CP  | CH  | Carica legna<br>Wood load | Prezzo<br>Price |
|-----------------------------|--------------------------|-----|-----|-----|-----|------|-----|-----|-----|-----|-----|-----|-----|-----|---------------------------|-----------------|
| GAC65iM                     | Marrone brown            | 755 | 775 | 815 | 980 | 1010 | 377 | 425 | 215 | 655 | 173 | 480 | 650 | 420 | 3 KG                      |                 |
| GAC65iG                     | Grigio Lava<br>Lava Grey |     |     |     |     |      |     |     |     |     |     |     |     |     |                           |                 |
| GAC80iM                     | Marrone brown            | 805 | 930 | 970 | 980 | 1010 | 402 | 425 | 245 | 810 | 200 | 480 | 800 | 420 | 3/4 kg                    |                 |
| GAC80iG                     | Grigio Lava<br>Lava Grey |     |     |     |     |      |     |     |     |     |     |     |     |     |                           |                 |

Dimensioni in millimetri, peso in Kg. - Dimensions in millimeters, weight in Kg.

Prezzi Iva esclusa / Prices are VAT or Taxes excluded

| Listino accessori / Accessories price list |                                 | Iva esclusa / VAT or Taxes excluded |   |  |  |
|--|---------------------------------|-------------------------------------|---|--|--|
| Per<br>For                                 | Supporto fisso<br>Special stand | Kit Porchetta<br>Kit for big roasts | Vetro Camera Combustione<br>Glass on combustion chamber |  |  |
| GAC 65i                                    | S65                             | GP65KIT                             | GAVTCC  |  |  |
| GAC 80i                                    | S80                             | GP80KIT                             | GAVTCC  |  |  |

Trovi altri accessori  
a pagina 86:  
mensolina frontale,  
teglie speciali  
pale pane pizza,  
porta pale,  
griglie e teglie aggiuntive...

More accessories  
at page 86:  
front shelf,  
special pans,  
bread and pizza shovels,  
shovel holder  
additional grilles and pans...



Frontale disponibile in due colorazioni - Sportello camera di combustione disponibile anche con vetro.  
Frontal panel available in two colors - Door of the combustion chamber available with or without glass.



Gli accessori  
più richiesti

The most popular  
accessories



Piana refrattaria aggiuntiva  
Additional refractory plate



Kit "Porchetta"



Teglia forata/ Perforated pan



Pala/ Shovel

# Quattrostagioni

ogni stagione é buona; inforni e cuoci dalla cucina o dal giardino, secondo il tempo che fa o come ti va  
work from the kitchen or from the garden, depending on the weather or as you wish

**5** anni di Garanzia  
su camere di cottura e combustione  
on baking and cooking chambers  
years warranty

**100%** Made  
in Italy

1 forno 2 facciate 4 stagioni  
**1 x 2 = 4**  
1 oven 2 fronts 4 seasons

Utilizza i frontali dei modelli da incasso ECO e STEEL, cioè: entrambi i Frontali ECO oppure un frontale ECO ed uno STEEL per abbinarlo al meglio con gli ambienti.

For this oven are used the front types of the ovens "ECO" and "STEEL", as follow:  
ECO + ECO or ECO + STEEL.

## DOTAZIONI DI SERIE

Valvole fumi e vapori, termometro, timer, illuminazione interna, 3 griglie cromate, 1 teglia rettangolare, 2 teglie rotonde, accessorio prenditeghe, attizzatoio, guanto e presina.

## STANDARD EQUIPMENT

Smoke and steam valves, thermometer, timer, internal lighting, 3 chrome grilles, 1 rectangular baking pan, 2 round baking pans, pan holder tool, poker, oven mitt and pan holder.

Vista frontale - View from the front

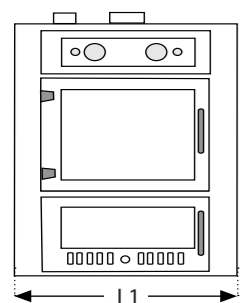

Vista laterale - View from the side

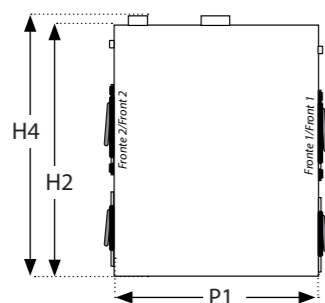

Vista dall'alto - View from the top

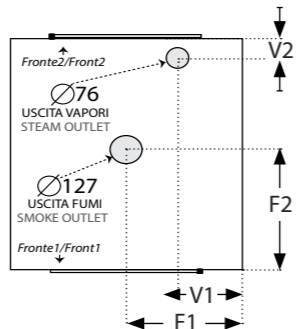

Camera di cottura - Cooking chamber

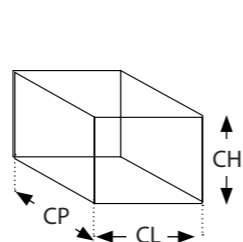

| Codice modello<br>Item code | Tipo frontali<br>type of fronts | L1  | P1  | H2  | H4   | F1  | F2  | V1  | V2 | KG  | CL  | CP  | CH  | Carica legna<br>Wood load | Prezzo<br>Price |
|-----------------------------|---------------------------------|-----|-----|-----|------|-----|-----|-----|----|-----|-----|-----|-----|---------------------------|-----------------|
| Quattrostagioni EE          | "ECO" + "ECO"                   | 755 | 800 | 980 | 1010 | 377 | 400 | 263 | 90 | 205 | 480 | 750 | 420 | 3 kg                      |                 |
| Quattrostagioni ES          | "ECO"+ "STEEL"                  | 755 | 800 | 980 | 1010 | 377 | 400 | 263 | 90 | 205 | 480 | 750 | 420 | 3 kg                      |                 |

Dimensioni in millimetri, peso in Kg. - Dimensions in millimeters, weight in Kg. Prezzi Iva esclusa / Prices are VAT or Taxes excluded

| Listino accessori / Accessories price list |                                 | Iva esclusa / VAT or Taxes excluded |   |  |  |
|--|---------------------------------|-------------------------------------|---|--|--|
| Per<br>For                                 | Supporto fisso<br>Special stand | Kit Porchetta<br>Kit for big roasts | Piana refrattaria agg.<br>Addit. refractory plate |  |  |
| Quattrostagioni                            | S65                             | GP65KIT                             | PB65  |  |  |

Trovi altri accessori a pagina 86: teglie speciali, pale pane pizza, porta pale, griglie e teglie aggiuntive... (nota: per gli accessori far riferimento ai forni da 65)

More accessories at page 86: special pans, bread and pizza shovels, shovel holder, additional grilles and pans... (note: for accessories refer to ovens of 65)

# FORNI A COMBUSTIONE SEPARATA DA INCASSO

BUILT IN SEPARATED COMBUSTION OVENS

# Quattrostagioni



Forno bifacciale che si incassa nel muro perimetrale che divide la cucina dalla veranda o dal giardino e lo usi in qualsiasi stagione.  
Bifrontal oven to be mounted inside the wall between kitchen and garden or porch; so that you can use it in any season.



visto da fuori / outdoor view

visto da dentro / indoor view



Puoi caricare la legna dall'esterno per non sporcare e cucinare dall'interno.

Puoi preparare i cibi ed infornarli dall'interno e poi sfornare e servirli dall'esterno.

You can load the wood from the outside so as not to dirty and cook from the inside.

You can prepare the food and bake it from the inside and then take it out and serve it from the outside.



## FORNI A COMBUSTIONE DIRETTA DA ESTERNO

---

### OUTDOOR DIRECT COMBUSTION OVENS

|              |       |
|--------------|-------|
| Più trecento | 56-57 |
| Nonna Luisa  | 58-59 |
| Benni        | 60-61 |
| Campagnolo   | 62-63 |
| Mino         | 64-65 |

# Più trecento

il grande forno per insaziabili buongustai

the great oven for insatiable gourmets

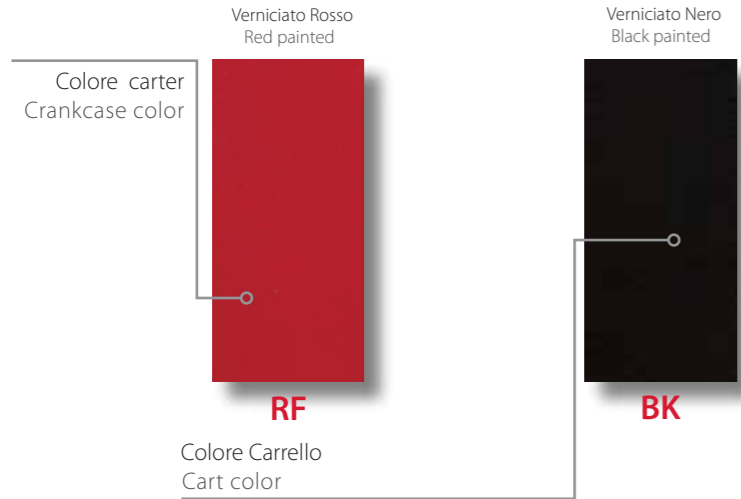

## Pizza pronta in 2 minuti

Accensione e riscaldamento in 10 minuti, poi solo altri 2 per cuocere una pizza



## Pizza ready in 2 minutes

10 minute for ignition and heating, then just 2 more minutes to bake a pizza

### DOTAZIONI DI SERIE

Termometro, attizzatoio, comignolo, braciere, guanto e presina.

### STANDARD EQUIPMENT

Thermometer, poker, chimney, brazier, oven mitt and pan holder.



Vista frontale - View from the front

Vista laterale - View from the side

Camera di cottura - Cooking chamber

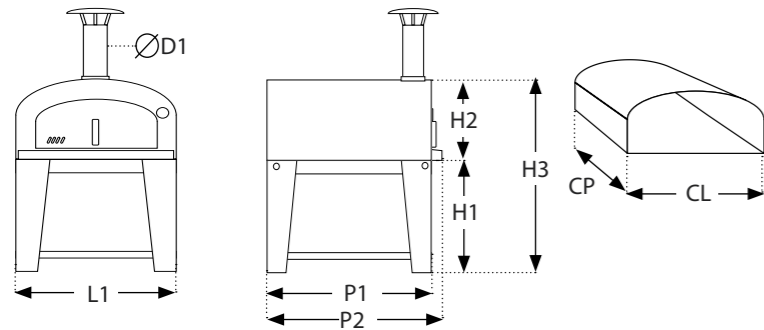

la versione a Gas non può essere fornita senza carrello che alloggia i controlli e sostiene il bruciatore



the gas version cannot be supplied without cart that houses the controls and supports the burner

| Codice     | Alimentaz. Fuel | Descrizione Info               | L1  | P1   | P2   | H1  | H2  | H3   | KG    | D1  | CL  | CP  | Prezzo Price |
|------------|-----------------|--------------------------------|-----|------|------|-----|-----|------|-------|-----|-----|-----|--------------|
| FPTCV      | Legna/Wood      | Forno + carrello / Oven + cart | 990 | 1085 | 1135 | 905 | 520 | 1425 | 197   | 150 | 800 | 900 |              |
| FPT        | Legna/Wood      | Solo forno / Only oven         | 990 | 1085 | 1135 |     | 520 |      | 158,5 | 150 | 800 | 900 |              |
| FPTCVG-B1E | Gas UE          | Forno + carrello / Oven + cart | 990 | 1085 | 1135 | 905 | 520 | 1425 | 230   | 150 | 800 | 900 |              |
| FPTCVG-B1U | Gas USA         | Forno + carrello / Oven + cart | 990 | 1085 | 1135 | 905 | 520 | 1425 | 230   | 150 | 800 | 900 |              |

Dimensioni in millimetri, peso in Kg. - Dimensions in millimeters, weight in Kg.

Prezzi Iva esclusa / Prices are VAT or Taxes excluded

| Listino accessori / Accessories price list |  | Iva esclusa / VAT or Taxes excluded |
|--|--|-------------------------------------|
| Codice Code                                | Articolo Item  | Prezzo Price                        |
| CFPV                                       | Carrello verniciato nero / Black painted cart          |                                     |
| PAFP                                       | Piano laterale / Side shelf                            |                                     |
|  | Kit 6 Pale + Portapale / Kit 6 shovels + shovel holder |                                     |
| CPFDPT                                     | Cappottina impermeabile / Waterproof cover             |                                     |

La versione a legna può essere trasformata a gas con l'acquisto dell'apposito kit

Trovi altri accessori a pagina 86:

The Gas version can be transformed into wood one with the purchase of the appropriate kit

More accessories at page 86:

# FORNI A COMBUSTIONE DIRETTA DA ESTERNO

OUTDOOR DIRECT COMBUSTION OVENS

# Più trecento



Frontali in acciaio Inox - Copertura verniciata colore rosso - Carrello indipendente verniciato nero - Grande camera di cottura.  
Front parts in stainless steel - Crankcase red painted - Black painted Stand-alone cart - Very wide cooking chamber.



Completa il tuo forno con il kit strumenti "SEI" e il porta pale

Complete your oven with the tool kit "SEI" and the shovel holder

### Alimentazione a legna - Wood fueled



### Alimentazione a Gas - Gas fueled



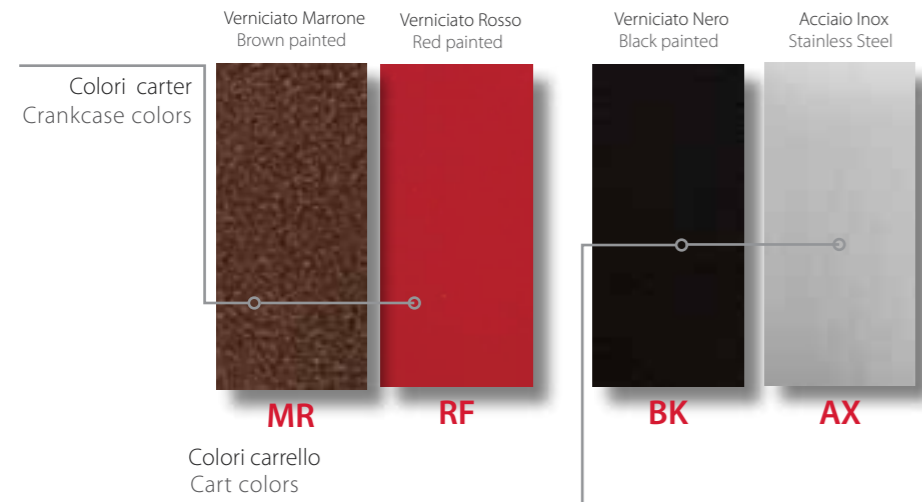

## Pizza pronta in 2 minuti

Accensione e riscaldamento in 10 minuti, poi solo altri 2 per cuocere una pizza



## Pizza ready in 2 minutes

10 minute for ignition and heating, then just 2 more minutes to bake a pizza

### DOTAZIONI DI SERIE

Termometro, attizzatoio, comignolo, braciere, guanto e presina.

### STANDARD EQUIPMENT

Thermometer, poker, chimney, brazier, oven mitt and pan holder.

Vista frontale - View from the front    Vista laterale - View from the side    Camera di cottura - Cooking chamber



la versione a Gas non può essere fornita senza carrello che alloggia i controlli e sostiene il bruciatore



the gas version cannot be supplied without cart that houses the controls and supports the burner

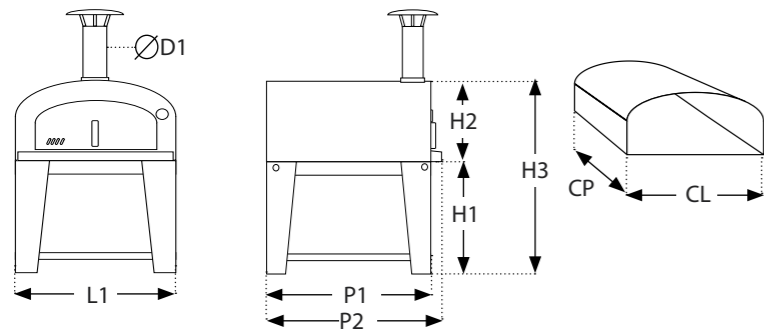

| Codice      | Alimentaz. Fuel | Descrizione Info                                  | L1  | P1  | P2  | H1  | H2  | H3   | KG    | D1  | CL  | CP  | Prezzo Price |
|-------------|-----------------|---|-----|-----|-----|-----|-----|------|-------|-----|-----|-----|--------------|
| FNLRCV      | Legna/Wood      | Forno + carrello verniciato Oven + painted cart   | 990 | 785 | 835 | 905 | 520 | 1425 | 136.5 | 150 | 800 | 600 |              |
| FNLRCX      | Legna/Wood      | Forno + carrello Inox Oven + Stainless steel cart | 990 | 785 | 835 | 905 | 520 | 1425 | 136.5 | 150 | 800 | 600 |              |
| FNLR        | Legna/Wood      | Solo forno / Oven only                            | 990 | 785 | 835 |     | 520 |      | 108.5 | 150 | 800 | 600 |              |
| FNLRCVG-B1E | Gas UE          | Forno + carrello verniciato Oven + painted cart   | 990 | 785 | 835 | 905 | 520 | 1425 | 169,0 | 150 | 800 | 600 |              |
| FNLRCVG-B1U | Gas USA         | Forno + carrello verniciato Oven + painted cart   | 990 | 785 | 835 | 905 | 520 | 1425 | 169,0 | 150 | 800 | 600 |              |

Dimensioni in millimetri, peso in Kg. - Dimensions in millimeters, weight in Kg.

Prezzi Iva esclusa / Prices are VAT or Taxes excluded

### Listino accessori / Accessories price list

| Codice Code | Articolo Item   | Prezzo Price |
|-------------|---|--------------|
| CFNV        | Solo Carrello verniciato nero / Only black painted cart |              |
| CFNX        | Solo Carrello Inox / Only stainless steel cart          |              |
| PAFN        | Piano laterale / Side shelf                             |              |
| CPFDNL      | Cappottina impermeabile / Waterproof cover              |              |

La versione a Gas può essere trasformata a legna con l'acquisto dell'apposito kit

Altri accessori a pagina 86

The Gas version can be transformed into wood one with the purchase of the appropriate kit

More optional equipments at page 86



Frontale in acciaio Inox - Carter di copertura verniciato rosso o marrone - Carrello indipendente verniciato nero o in acciaio.  
Front panel in stainless steel - Crankcase red or brown painted - Stand-alone cart black painted or made in stainless steel.



La versione a gas di "Nonna Luisa"

The gas version of "Nonna Luisa"

### Alimentazione a legna - Wood fueled



### Alimentazione a Gas - Gas fueled



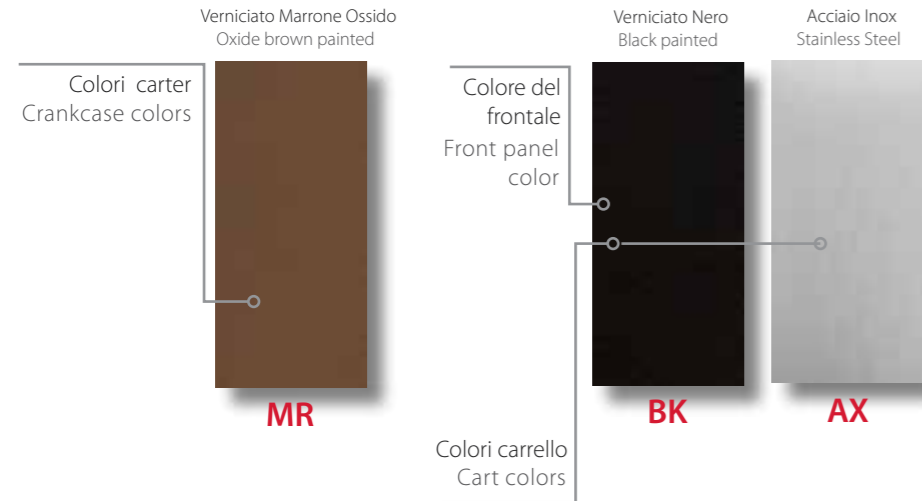

## Pizza pronta in 2 minuti

Accensione e riscaldamento in 10 minuti, poi solo altri 2 per cuocere una pizza



## Pizza ready in 2 minutes

10 minute for ignition and heating, then just 2 more minutes to bake a pizza

### DOTAZIONI DI SERIE

Termometro, attizzatoio, comignolo con valvola, braciere, guanto.

### STANDARD EQUIPMENT

Thermometer, poker, chimney with valve, brazier, oven mitt.

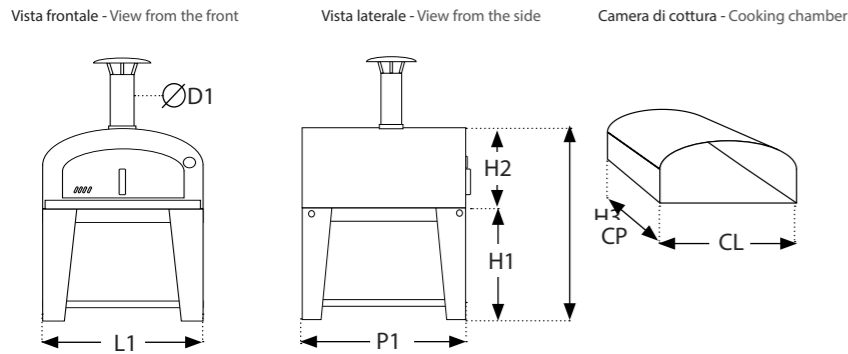

| Codice | Alimentaz. Fuel | Descrizione Info                                     | L1  | P1  | H1  | H2  | H3   | KG  | D1  | CL  | CP  | Prezzo Price |
|--------|-----------------|--|-----|-----|-----|-----|------|-----|-----|-----|-----|--------------|
| FBERCV | Legna/Wood      | Forno + carrello verniciato<br>Oven + painted cart   | 985 | 840 | 905 | 500 | 1405 | 126 | 130 | 800 | 600 |              |
| FBERCX | Legna/Wood      | Forno + carrello Inox<br>Oven + Stainless steel cart | 985 | 840 | 905 | 500 | 1405 | 126 | 130 | 800 | 600 |              |
| FBER   | Legna/Wood      | Solo forno / Oven only                               | 985 | 840 |     | 500 |      | 98  | 130 | 800 | 600 |              |

Dimensioni in millimetri, peso in Kg. - Dimensions in millimeters, weight in Kg.

Prezzi Iva esclusa / Prices are VAT or Taxes excluded

| Listino accessori / Accessories price list |   | Iva esclusa / VAT or Taxes excluded |
|--|---|-------------------------------------|
| Codice Code                                | Articolo Item   | Prezzo Price                        |
| CFNV                                       | Solo Carrello verniciato nero / Only black painted cart                     |                                     |
| CFNX                                       | Solo Carrello Inox / Only stainless steel cart                              |                                     |
| PAFC                                       | Piano laterale / Side shelf   |                                     |
| CPFDNL                                     | Cappottina impermeabile / Waterproof cover                                  |                                     |
| CMUM+CMUME                                 | Carrello Cucina modulare con estensione/Modular kitchen cart with extension |                                     |

Altri accessori a pagina 86

More optional equipments at page 86

Carter di copertura verniciato marrone ossido- Frontale verniciato nero - Carrello indipendente verniciato nero.  
Crankcase Oxide brown painted - Front panel black painted - Stand-alone cart black painted.





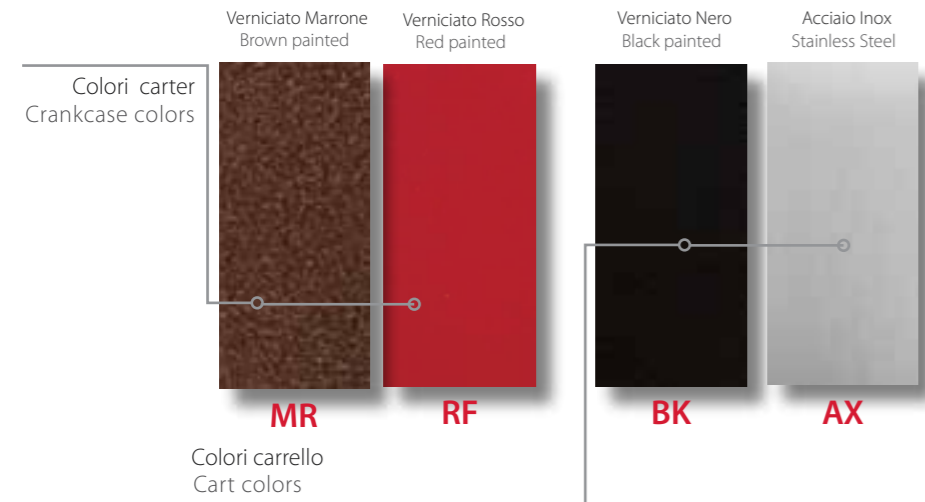

## Pizza pronta in 2 minuti

Accensione e riscaldamento in 10 minuti, poi solo altri 2 per cuocere una pizza



## Pizza ready in 2 minutes

10 minute for ignition and heating, then just 2 more minutes to bake a pizza

### DOTAZIONI DI SERIE

Termometro, attizzatoio, comignolo, braciere, guanto e presina.

### STANDARD EQUIPMENT

Thermometer, poker, chimney, brazier, oven mitt and pan holder.



Vista frontale - View from the front    Vista laterale - View from the side    Camera di cottura - Cooking chamber

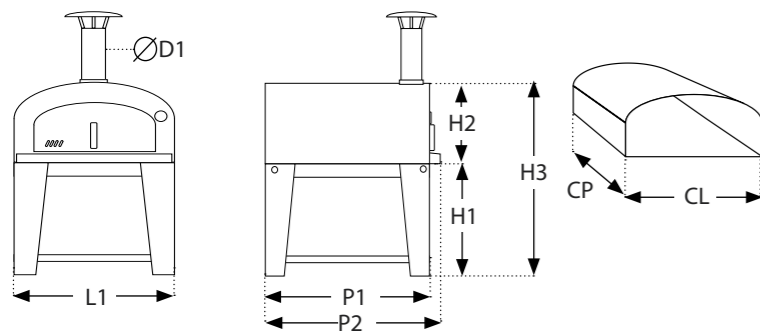

| Codice | Alimentaz. Fuel | Descrizione Info                                  | L1  | P1  | P2  | H1  | H2  | H3   | KG   | D1  | CL  | CP  | Prezzo Price |
|--------|-----------------|---|-----|-----|-----|-----|-----|------|------|-----|-----|-----|--------------|
| FCARCV | Legna/Wood      | Forno + carrello verniciato Oven + painted cart   | 790 | 690 | 740 | 800 | 520 | 1320 | 96.5 | 150 | 600 | 500 |              |
| FCARCX | Legna/Wood      | Forno + carrello Inox Oven + Stainless steel cart | 790 | 690 | 740 | 800 | 520 | 1320 | 96.5 | 150 | 600 | 500 |              |
| FCAR   | Legna/Wood      | Solo forno / Oven only                            | 790 | 690 | 740 |     | 520 |      | 77   | 150 | 600 | 500 |              |

Dimensioni in millimetri, peso in Kg. - Dimensions in millimeters, weight in Kg.

Prezzi Iva esclusa / Prices are VAT or Taxes excluded

| Listino accessori / Accessories price list |  | Iva esclusa / VAT or Taxes excluded |
|--|--|-------------------------------------|
| Codice Code                                | Articolo Item  | Prezzo Price                        |
| CFCV                                       | Solo Carrello verniciato nero /Only black painted cart   |                                     |
| CFCX                                       | Solo Carrello Inox /Only stainless steel cart  |                                     |
| PAFC                                       | Piano laterale /side shelf   |                                     |
| CMUM+CMUME+ACK04C                          | Carrello cucina + estensione + kit 4strumenti ACK04C Modular kitchen cart + extension + kit of four tools ACK04C |                                     |

Altri accessori a pagina 86

More optional equipments at page 86



Carter di copertura verniciato rosso o marrone - Frontale in acciaio Inox - Carrello indipendente verniciato nero o in acciaio.  
Crankcase red or brown painted - Front panel in stainless steel - Stand-alone cart black painted or made in stainless steel.



Kit strumenti "QUATTRO" e porta pale, per cucinare al meglio  
Tool kit "QUATTRO" and shovel holder, very useful equipments



# Mino

Il forno facile da portare ovunque vuoi

The handy oven to take wherever you want

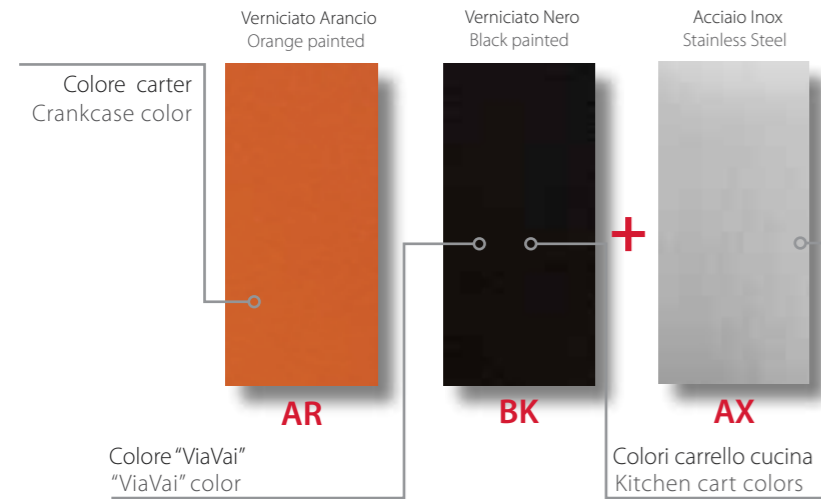

Pizza pronta in 2 minuti

Accensione e riscaldamento in 10 minuti, poi solo altri 2 per cuocere una pizza

## DOTAZIONI DI SERIE

Termometro digitale, comignolo con valvola, braciere, guanto.

## STANDARD EQUIPMENT

Digital thermometer, chimney with valve, brazier, oven mitt.



Pizza ready in 2 minutes

10 minute for ignition and heating, then just 2 more minutes to bake a pizza

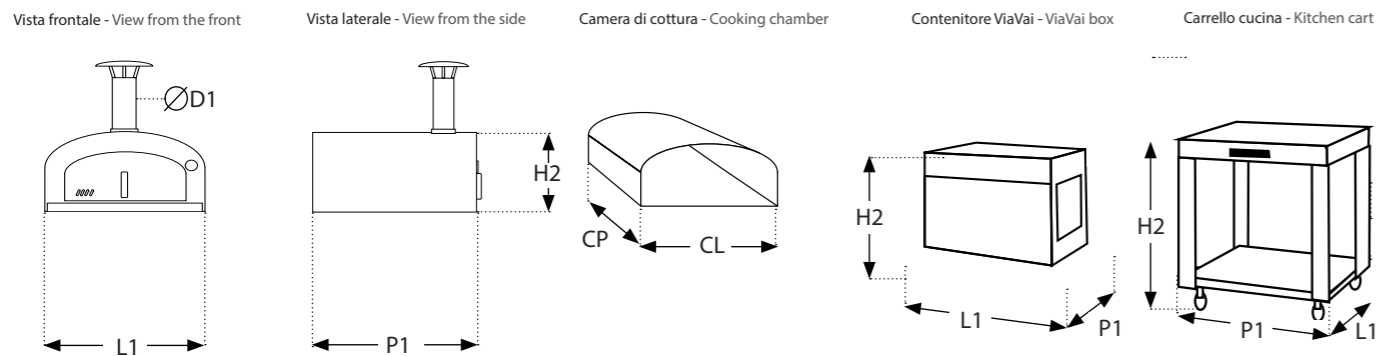

| Codice Code | Descrizione Info   | Alimentaz. Fuel | L1  | P1  | H1 | H2  | H3 | KG | D1  | CL  | CP  | Prezzo Price |
|-------------|--|-----------------|-----|-----|----|-----|----|----|-----|-----|-----|--------------|
| FMIR        | Forno / Oven   | Legna/Wood      | 705 | 485 |    | 315 |    | 34 | 100 | 600 | 400 |              |
| CCOVV       | VIAVAI contenitore attrezzato per trasporto forno<br>VIAVAI equipped container to transport the oven |                 | 750 | 570 |    | 550 |    | 25 |     |     |     |              |
| CMUM        | Carrello cucina modulare / Modular kitchen cart  |                 | 705 | 775 |    | 900 |    | 28 |     |     |     |              |
| CMUME       | Prolunga carrello cucina / Extension for kitchen cart  |                 | 705 | 775 |    | 900 |    | 33 |     |     |     |              |

Dimensioni in millimetri, peso in Kg. - Dimensions in millimeters, weight in Kg.

Prezzi Iva esclusa / Prices are VAT or Taxes excluded

| Listino accessori / Accessories price list |  | Iva esclusa / VAT or Taxes excluded |              |
|--|--|-------------------------------------|--------------|
| Codice Code                                | Articolo Item  | Dimensioni Dimensions               | Prezzo Price |
| ACK04C                                     | Kit 4 strumenti per Carrello cucina CMUM<br>Kit 4 tool for kitchen cart CMUM |                                     |              |

Altri accessori a pagina 86

More optional equipments at page 86

# FORNI A COMBUSTIONE DIRETTA DA ESTERNO

OUTDOOR DIRECT COMBUSTION OVENS

# Mino



Carter di copertura verniciato arancione - Frontale verniciato nero - Carrello cucina multiuso verniciato nero, top acciaio.  
Crankcase orange painted - Front panel black painted - Multipurpose Kitchen cart black painted with stainless steel top.

Carrello cucina modulare multiuso con piano in acciaio Inox

Multi-purpose modular kitchen cart with stainless steel top



Carrello cucina con estensione  
Kitchen cart with extension



**ViaVai** il contenitore per portare ovunque il tuo Mino  
your Mino everywhere

**Il set da viaggio per il tuo Mino** The travel set for your Mino

Un contenitore per trasportare il forno che funge anche da supporto, con lo sportello che diventa un piano di servizio; completo degli strumenti essenziali per cucinare dove vuoi:  
- pala teglia multiuso  
- palino tondo,  
- spazzola,  
- Paletta per ceneri

A container to transport the oven that also acts as a stand, with the door that becomes a service surface; complete of the essential tools for cooking wherever you want:  
- multipurpose plate,  
- small round shovel,  
- brush for ashes,  
- ash shovel.

"ViaVai" diventa supporto per il forno  
"ViaVai" becomes a stand for the oven

Lo sportello diventa mensola di lavoro  
The door becomes a work shelf



## **BARBECUE STAND ALONE BARBECUE PER FORNI**

---

## **STAND ALONE BARBECUES BARBECUES FOR OVEN**

### **STAND-ALONE**

|         |       |
|---------|-------|
| Easy Up | 68-69 |
| Maxi    | 70-71 |

### **PER FORNI - FOR OVENS**

|              |       |
|--------------|-------|
| Falò         | 72-73 |
| Cassetto BBQ | 72-73 |

# Easy Up

il piccolo dalle grandi prestazioni

Small barbecue, great performances

BARBECUE INDIPENDENTI  
STAND ALONE BARBECUES

Easy Up

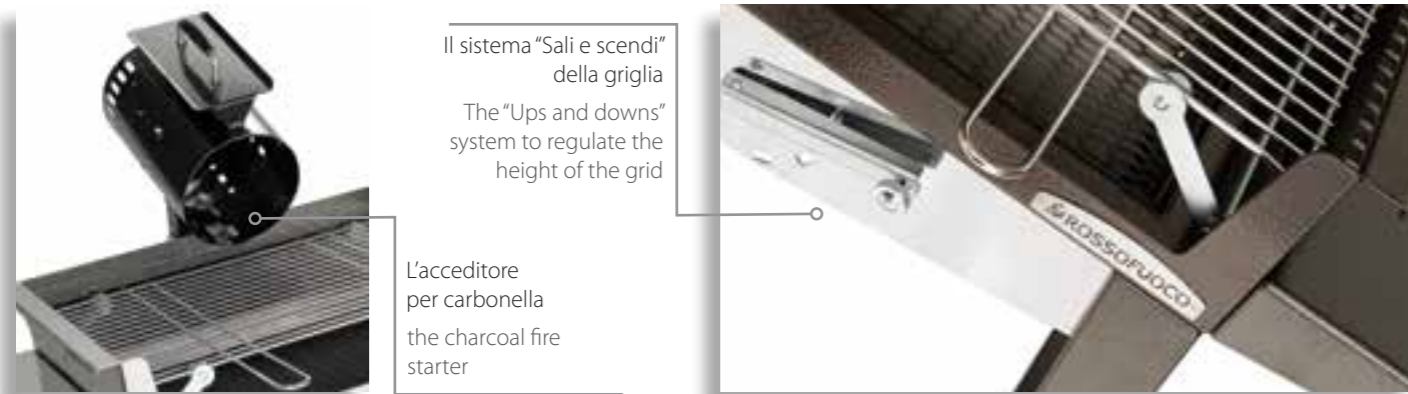

Il sistema "Sali e scendi" della griglia  
The "Ups and downs" system to regulate the height of the grid

L'accettore per carbonella  
the charcoal fire starter

## DOTAZIONI DI SERIE

Griglia con sistema "Sali e Scendi"

## STANDARD EQUIPMENT

Grid with "ups and downs" system

100% Made in Italy

Barbecue a carbonella da giardino verniciato, con sistema "Saliscendi" completo di griglia.  
Painted charcoal barbecue for garden, with "Ups and downs" system complete with grid.

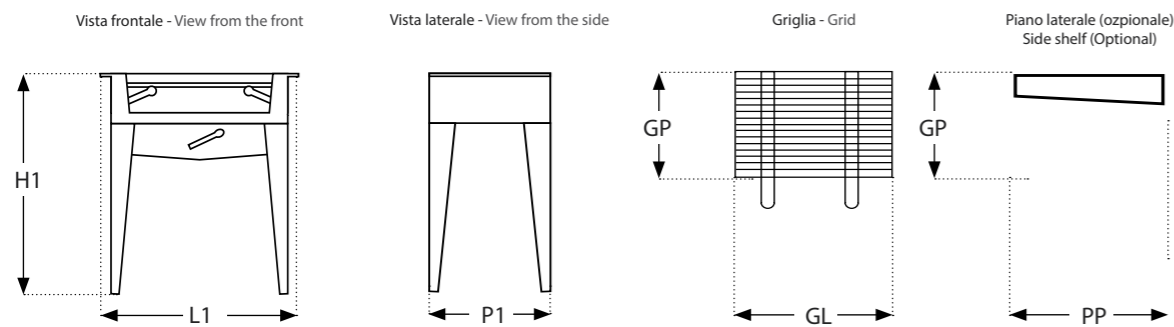

| Codice Code | Descrizione Info  | Alimentaz. Fuel     | L1  | P1  | H1  | KG | GL  | GP  | PP  | Prezzo Price |
|-------------|---|---------------------|-----|-----|-----|----|-----|-----|-----|--------------|
| EASYUP      | Barbecue Easy UP senza piani laterali / Easy UP barbecue without side shelves | Carbonella Charcoal | 650 | 450 | 920 | 50 | 640 | 400 | 300 |              |

Dimensioni in millimetri, peso in Kg. - Dimensions in millimeters, weight in Kg. Prezzi Iva esclusa / Prices are VAT or Taxes excluded

| Listino accessori / Accessories price list |   | Iva esclusa / VAT or Taxes excluded |
|--|---|-------------------------------------|
| Codice Code                                | Articolo Item   | Prezzo Price                        |
| GBX65X                                     | Supplemento x griglia Inox / Surcharge for Inox grid                  |                                     |
| PBV  | Coppia piani laterali verniciati / Couple of painted side shelves     |                                     |
| ACB  | Accenditore carbonella (verniciato) / Charcola fire starter (painted) |                                     |
| GB65                                       | Griglia aggiuntiva cromata/ Additional chrome grid                    |                                     |
| GB65X                                      | Griglia aggiuntiva Inox/ Additional Inox grid                         |                                     |
| CPBBEU                                     | Cappottina impermeabile / Waterproof cover                            |                                     |

Altri accessori a pagina 86

More optional equipments at page 86

Gli accessori più richiesti

The most popular accessories



Cappottina/Cover



Plani laterali/Side Shelves

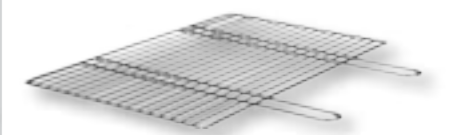

Griglia supplementare inox / Additional Inox grid

# Maxi

fantastico anche per agriturismi e ristoranti

fantastic for farmhouses and restaurants too

BARBECUE INDIPENDENTI  
STAND ALONE BARBECUES

Maxi



100% Made in Italy

Il cassetto raccogli cenere  
The ash tray

Il braciere posteriore per ricavare carbone dalla legna  
The rear brazier to obtain coal from wood



## DOTAZIONI DI SERIE

Braciere posteriore per legna, 1 griglia, Cassetto raccogli cenere, 2 piani laterali estraibili, ruote posteriori, manici anteriori estraibili

## STANDARD EQUIPMENT

Rear burner for wood, 1 grill, ash tray, 2 lateral retractable shelves, rear wheels, extractable front handles

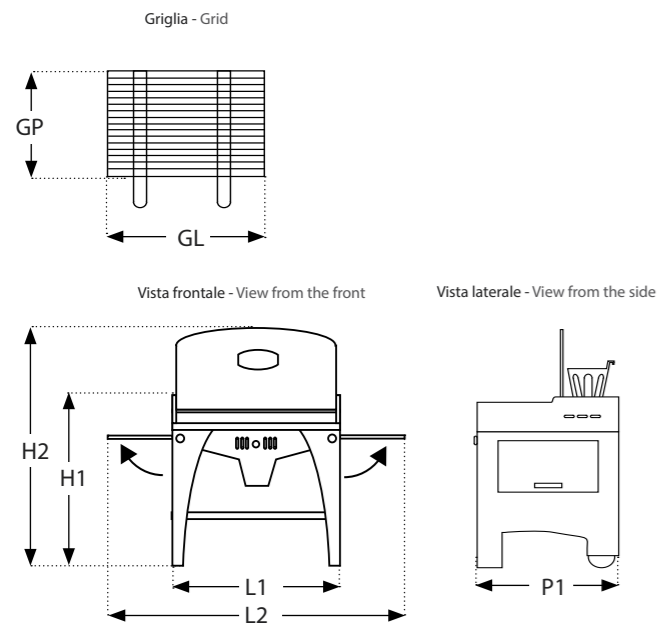

| Codice Code | Descrizione Info   | Alimentaz. Fuel                        | L1  | L2   | P1  | H1  | H2   | KG | GL  | GP  | Prezzo Price |
|-------------|--|--|-----|------|-----|-----|------|----|-----|-----|--------------|
| MAXI        | Barbecue MAXI con 2 piani laterali a scomparsa<br>Barbecue with 2 retractable side shelves | Legna o carbonella<br>Wood or charcoal | 840 | 1400 | 810 | 950 | 1350 | 70 | 790 | 400 |              |

Dimensioni in millimetri, peso in Kg. - Dimensions in millimeters, weight in Kg.

Prezzi Iva esclusa / Prices are VAT or Taxes excluded

| Listino accessori / Accessories price list |   | Iva esclusa / VAT or Taxes excluded |
|--|---|-------------------------------------|
| Codice Code                                | Articolo Item   | Prezzo Price                        |
| GBX80X                                     | Supplemento x griglia Inox / Surcharge for Inox grid                  |                                     |
| ACF  | Accenditore carbonella (verniciato) / Charcola fire starter (painted) |                                     |
| GB80                                       | Griglia aggiuntiva cromata / Additional chrome grid                   |                                     |
| GB80X                                      | Griglia aggiuntiva Inox / Additional Inox grid                        |                                     |
| CPBBMX                                     | Cappottina impermeabile / Waterproof cover                            |                                     |

Altri accessori a pagina 86

More optional equipments at page 86

Robustissimo semiprofessionale - Braciere posteriore per produrre carbone dalla legna - Mensole laterali a scomparsa.  
Very robust semi-professional barbecues - Rear brazier to generate coal from wood - Retractable side shelves.



Gli accessori più richiesti

The most popular accessories



Cappottina/Cover



Accenditore carbone/Charcoal fire starter

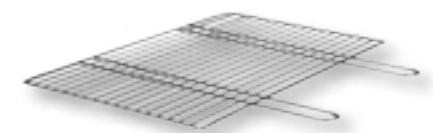

Griglia supplementare Inox / Additional grid in Inox

## Cassetto BBQ

Applicabile a tutti i forni da 80 da esterno; trasforma la camera di combustione in un barbecue

It can be mounted on all outdoor ovens type 80, and transforms the combustion chamber into a barbecue

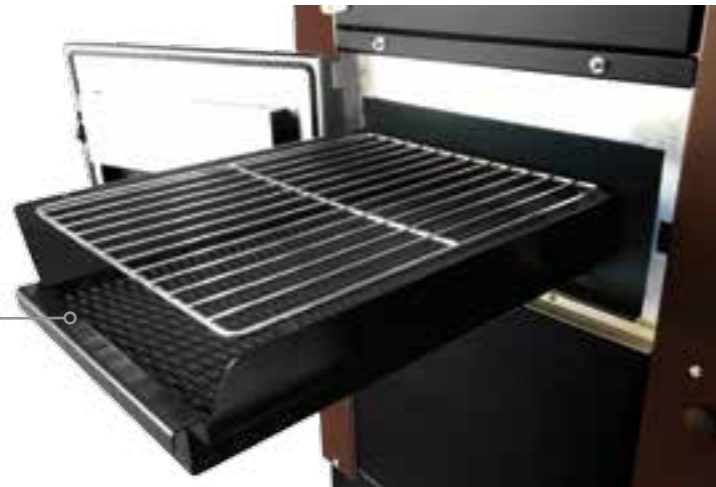

| Codice Code | Descrizione Info   | Alimentaz. Fuel                        | L1 | P1 | H1 | KG | GL  | GP  | D1 | Prezzo Price |
|-------------|--|--|----|----|----|----|-----|-----|----|--------------|
| BCF         | CASSETTO BBQ Barbecue estraibile per forni da 80<br>Pull out BBQ for ovens type 80 | Legna o carbonella<br>Wood or charcoal |    |    |    |    | 480 | 390 |    |              |

*Dimensioni in millimetri, peso in Kg. - Dimensions in millimeters, weight in Kg. Prezzi Iva esclusa / Prices are VAT or Taxes excluded*

## DOTAZIONI DI SERIE

**Falò:** Braciare per legna, 1 griglia, cassetto raccogli cenere, tetto verniciato, comignolo antivento  
**Cassetto BBQ:** 1 griglia

## STANDARD EQUIPMENT

**Falò:** Burner for wood, 1 grid, ash tray, varnished roof, windproof chimney  
**Cassetto BBQ:** 1 grid

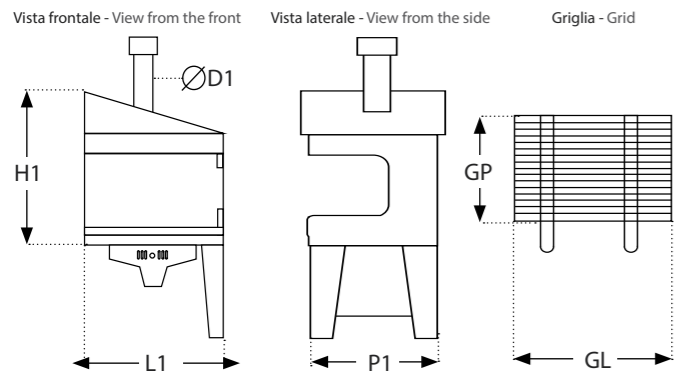

| Codice Code | Descrizione Info  | Alimentaz. Fuel                        | L1  | P1  | H1  | KG | GL  | GP  | D1  | Prezzo Price |
|-------------|---|--|-----|-----|-----|----|-----|-----|-----|--------------|
| BEF         | Barbecue laterale FALÒ, tetto verniciato<br>Side barbecue FALÒ for oven with painted roof | Legna o carbonella<br>Wood or charcoal | 740 | 930 | 950 | 70 | 640 | 400 | 130 |              |

*Dimensioni in millimetri, peso in Kg. - Dimensions in millimeters, weight in Kg. Prezzi Iva esclusa / Prices are VAT or Taxes excluded*

### Listino accessori / Accessories price list *Iva esclusa / VAT or Taxes excluded*

| Codice Code | Per For | Articolo Item  | Prezzo Price |
|-------------|---------|--|--------------|
| BTX         | Falò    | Supplemento per tetto Inox<br>Surcharge for roof made in stainless steel   |              |
| GBX65X      | Falò    | Supplemento per griglia Inox<br>Surcharge for grid made in stainless steel |              |

Altri accessori a pagina 86

More optional equipments at page 86



Due soluzioni per trasformare il forno in una postazione di cottura completa.  
Two solutions to transform the oven into a complete cooking station.



## Falò

Modello ad accesso frontale alimentato a legna o carbone per tutti i forni da esterno escluso modello 50

It's a front access barbecue powered by wood or charcoal, for all outdoor ovens except type 50

RISCALDATORI PIROLITICI A PELLETTA  
DA ESTERNO

---

OUTDOOR  
WOOD PELLET PATIO HEATERS

|          |       |
|----------|-------|
| Rubino   | 76-77 |
| Diamante | 78-79 |

# Rubino

Un caldo abbraccio che non finisce mai

a neverending warmth



## CARATTERISTICHE

Economico ed ecologico, alimentato a pellet, combustione pulita, maneggevole pratico e facile da usare, ruote per lo spostamento, irraggiamento fino a 2 metri, non necessita di elettricità, adatto a tutti gli spazi aperti.

## FEATURES

Cheap and ecological, pellet powered, clean combustion, easy to handle and to use, wheels for moving irradiation up to 2 meters, it does not require electricity, suitable for all open spaces.

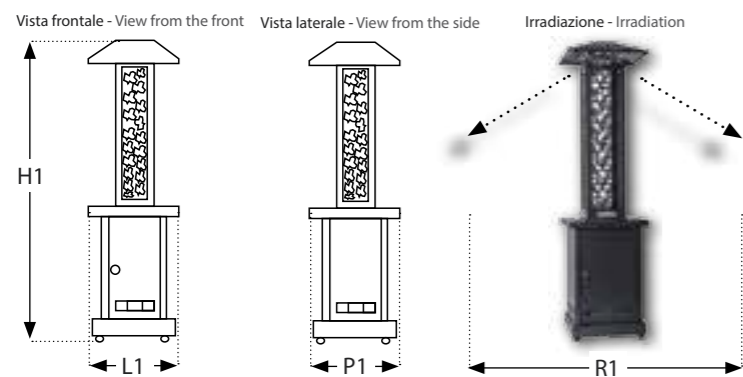

| Codice Code | Descrizione Info | L1  | P1  | H1   | KG | R1  | Carica Pellet/ Wood pellet load | Durata carica/Load autonomy | Prezzo Price |
|-------------|------------------|-----|-----|------|----|-----|---------------------------------|-----------------------------|--------------|
| RPRB01      | Rubino           | 500 | 500 | 1960 | 55 | 400 | 3 - 9 kg.                       | 1,5 - 6 ore/hours           |              |

Dimensioni in millimetri, peso in Kg. - Dimensions in millimeters, weight in Kg.      Prezzi Iva esclusa / Prices are VAT or Taxes excluded

| Listino accessori / Accessories price list |  | Iva esclusa / VAT or Taxes excluded |
|--|--|-------------------------------------|
| Codice Code                                | Articolo Item                              | Prezzo Price                        |
| CPRPRB                                     | Cappottina impermeabile / Waterproof cover |                                     |

Trovi tutti i ricambi a pagina 86

For spare parts go to page 86

# RISCALDATORI PIROLITICI PER ESTERNO

OUTDOOR WOOD PELLET PATIO HEATERS

# Rubino



Un elegante e potente riscaldatore pirolitico ad elevata autonomia.  
A charming and powerful pyrolytic heater with high autonomy.

### Esclusivo Sistema di "Scarico a caldo"

Permette di scaricare interamente i residui della combustione, dal braciere al sottostante cassetto raccoglitore; si può ricaricare e riaccendere subito senza attese.

### "Hot emptying" exclusive system

It allows you to completely discharge the combustion residues, from the brazier to the underlying collection drawer; you can recharge and restart immediately without waiting.

### Non usa elettricità o batterie

Nessun problema di allaccio alla rete elettrica, o di batterie da ricaricare, nessun problema di guasti alla ventola, di cavi elettrici o di improvvisi black out.

### No electricity or batteries needed

No problem of connection to the power supply, or batteries to be recharged, no problem of fan failure, of electrical cables or of sudden black outs.

### Economico ed ecologico

Spendi meno di 0,50 euro all'ora. Emissione di CO2 inferiore ai riscaldatori a gas, inoltre il pellet è un combustibile ecologico i cui residui diventano un ottimo fertilizzante.

### Cheap and eco friendly

Spend less than 0.50 euros per hour. CO2 emission lower than gas heaters, moreover Pellet is an ecological fuel whose residues become an excellent fertilizer.





# Diamante

Un caldo abbraccio che non finisce mai

a neverending warmth



## CARATTERISTICHE

Economico ed ecologico, alimentato a pellet, combustione pulita, maneggevole pratico e facile da usare, ruote per lo spostamento, non necessita di elettricità, adatto a tutti gli spazi aperti.

## FEATURES

Cheap and ecological, pellet powered, clean combustion, easy to handle and to use, wheels for moving, it does not require electricity, suitable for all open spaces.



Vista frontale - View from the front Vista laterale - View from the side

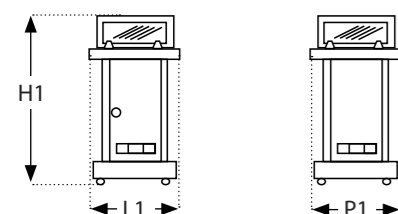

| Codice Code | Descrizione Info | L1  | P1  | H1  | KG | R1  | Carica Pellet/ Wood pellet load | Durata carica/Load autonomy | Prezzo Price |
|-------------|------------------|-----|-----|-----|----|-----|---------------------------------|-----------------------------|--------------|
| RPDM01      | Diamante         | 500 | 500 | 960 | 35 | 400 | 3 - 9 kg.                       | 1,5 - 6 ore/hours           |              |

Dimensioni in millimetri, peso in Kg. - Dimensions in millimeters, weight in Kg.

Prezzi Iva esclusa / Prices are VAT or Taxes excluded

| Listino accessori / Accessories price list |  | Iva esclusa / VAT or Taxes excluded |
|--|--|-------------------------------------|
| Codice Code                                | Articolo Item                              | Prezzo Price                        |
| CPRPDM                                     | Cappottina impermeabile / Waterproof cover |                                     |

Trovi tutti i ricambi a pagina 86

For spare parts go to page 86

# RISCALDATORI PIROLITICI PER ESTERNO

OUTDOOR WOOD PELLET PATIO HEATERS

# Diamante



Un elegante e potente riscaldatore pirolitico ad elevata autonomia.  
A charming and powerful pyrolytic heater with high autonomy.

### Esclusivo Sistema di "scarico a Caldo"

Permette di scaricare interamente i residui della combustione, dal braciere al sottostante cassetto raccoglitore; si può ricaricare e riaccendere subito senza attese.

### "Hot emptying" exclusive system

It allows you to completely discharge the combustion residues, from the brazier to the underlying collection drawer; you can recharge and restart immediately without waiting.

### Non usa elettricità o batterie

Nessun problema di allaccio alla rete elettrica, o di batterie da ricaricare, nessun problema di guasti alla ventola, di cavi elettrici o di improvvisi black out.

### No electricity or batteries needed

No problem of connection to the power supply, or batteries to be recharged, no problem of fan failure, of electrical cables or of sudden black outs.

### Economico ed ecologico

Spendi meno di 0,50 euro all'ora. Emissione di CO2 inferiore ai riscaldatori a gas, inoltre il pellet è un combustibile ecologico i cui residui diventano un ottimo fertilizzante.

### Cheap and eco friendly

Spend less than 0.50 euros per hour. CO2 emission lower than gas heaters, moreover Pellet is an ecological fuel whose residues become an excellent fertilizer.



## ACCESSORI E RICAMBI

---

## OPTIONAL EQUIPMENTS SPARE PARTS

|                                 |       |
|---------------------------------|-------|
| Accessori / Optional equipments | 82-89 |
| Ricambi / Spare parts           | 90-94 |
| Tabella colori / Color chart    | 95    |

### LEGENDA DEI SIMBOLI / MEANING OF SYMBOLS

- ES** = Per forni da esterno / For outdoor ovens
- IS** = Per forni da incasso / For built-in ovens
- ED** = Per forni a cottura diretta / For direct cooking ovens
- BQ** = Per barbecues / For barbecues
- PH** = Per riscaldatori / For heaters

## IS Kit conversione forno da incasso a esterno / Set to convert a Built in oven into an outdoor oven



| Codice Code | Descrizione / Informazioni prodotto<br>Description / Item's info           | Serie forno<br>Ovens series | Peso<br>Weight | Prezzo<br>Price |
|-------------|--|-----------------------------|----------------|-----------------|
| KEV50       | Kit per forni, tetto Verniciato / Kit for ovens, roof painted              | 50                          |                |                 |
| KEV65       | Kit per forni, tetto Verniciato / Kit for ovens, roof painted              | 65                          |                |                 |
| KEV65X      | Kit per forni, tetto Acciaio Inox / Kit for ovens, roof in stainless steel | 65                          |                |                 |
| KEV80       | Kit per forni, tetto Verniciato / Kit for ovens, roof painted              | 80                          |                |                 |
| KEV80X      | Kit per forni, tetto Acciaio Inox / Kit for ovens, roof in stainless steel | 80                          |                |                 |
| KEV100      | Kit per forni, tetto Verniciato / Kit for ovens, roof painted              | 100                         |                |                 |
| KEV100X     | Kit per forni, tetto Acciaio Inox / Kit for ovens, roof in stainless steel | 100                         |                |                 |
| KEVWX       | Kit per forni, tetto Acciaio Inox / Kit for ovens, roof in stainless steel | Sedicinoni                  |                |                 |

## ES Carrelli per forni a combustione separata / Carts for separated combustion ovens



| Codice Code | Descrizione / Informazioni prodotto<br>Description / Item's info | Serie forno<br>Ovens series | Dimensioni<br>dimensions | Peso<br>Weight | Prezzo<br>Price |
|-------------|--|-----------------------------|--------------------------|----------------|-----------------|
| C50         | Verniciato / Painted   | 50                          | 615x650x715              | 30             |                 |
| C65         | Verniciato / Painted   | 65                          | 755x775x650              | 42             |                 |
| C65X        | Inox / Stainless steel   | 65                          | 755x775x650              | 42             |                 |
| C80         | Verniciato / Painted   | 80                          | 805x930x650              | 50             |                 |
| C80X        | Inox / Stainless steel   | 80                          | 805x930x650              | 50             |                 |
| CW          | Verniciato nero / Black painted                                  | Sedicinoni                  | 1005x780x640             | 53             |                 |
| CWA         | Verniciato Marrone, vano aperto / Brown painted, without door    | Sedicinoni Country          | 1005x780x640             | 53             |                 |
| C100        | Verniciato / Painted   | 100                         | 805x1120x650             | 53             |                 |
| C100X       | Inox / Stainless steel   | 100                         | 805x1120x650             | 53             |                 |

## ED Carrelli per forni a cottura diretta / Carts for direct cooking ovens



| Codice Code | info prodotto<br>Item's info    | Forno<br>Oven     | Dimensioni<br>dimensions | Peso<br>Weight | Prezzo<br>Price |
|-------------|---------------------------------|-------------------|--------------------------|----------------|-----------------|
| CPTV        | Verniciato Nero / Black painted | Più trecento      | 990x1085x905             | 38,5           |                 |
| CFNV        | Verniciato Nero / Black painted | Nonna Luisa/Benni | 990x785x905              | 28             |                 |
| CFNX        | Inox / Stainless steel          | Nonna Luisa/Benni | 990x785x905              | 28             |                 |
| CFCV        | Verniciato Nero / Black painted | Campagnolo        | 790x690x850              | 19,5           |                 |
| CFCX        | Inox / Stainless steel          | Campagnolo        | 790x690x850              | 19,5           |                 |

## ED Carrelli e supporti multiuso / Multipurpose carts and stands



| Codice Code | info prodotto<br>Item's info  | Dimensioni<br>dimensions | Peso<br>Weight | Prezzo<br>Price |
|-------------|---|--------------------------|----------------|-----------------|
| CMUM        | Carrello cucina multiuso modulare<br>Multi-purpose modular kitchen cart   | 705x775x900              | 28             |                 |
| CMUME       | Prolunga per carrello cucina multiuso modulare<br>Extension for multi-purpose modular kitchen cart  | 705x775x900              | 33             |                 |
| CCOV        | VIA VAI Contenitore attrezzato x trasporto forno Mino<br>completo di 1 Pala-tegla multiuso, 1 Palino tondo, 1 spazzola, 1 paletta ceneri<br>VIA VAI Equipped container for oven MINO transport<br>complete with 1 Multipurpose plate, 1 small round pizza shovel, 1 brush for ashes, 1 ash shovel | 750x570x550              | 25             |                 |

## IS Supporti per forni a combustione separata / Special stands for separated combustion ovens



| Codice Code | Serie forno<br>Ovens series | Dimensioni<br>dimensions | Peso<br>Weight | Prezzo<br>Price |
|-------------|-----------------------------|--------------------------|----------------|-----------------|
| S50         | 50                          | 630x650x715              | 15             |                 |
| S65         | 65                          | 770x775x650              | 14             |                 |
| S80         | 80                          | 820x930x650              | 50             |                 |
| SW          | Sedicinoni                  | 1020x780x640             | 53             |                 |
| S100        | 100                         | 820x1120x650             | 53             |                 |

## ES FALO' Barbecue a legna per forni / Wood fueled barbecue for separated combustion ovens

Si applica ad uno dei lati del forno, si utilizza lavorando frontalmente anzichè lateralmente;  
Alimentato a legna è un accessorio che trasforma il forno in una stazione di cottura completa.

Can be fixed to one or the other side of your outdoor oven to transform it in a complete cooking station.  
Fueled by wood, you can operate frontally instead of laterally.



| Codice Code | Descrizione / Informazioni prodotto<br>Description / Item's info          | Serie forno<br>Ovens series | Dimensioni<br>dimensions | Dimensioni griglia<br>Grid's dimensions | Peso<br>Weight | Prezzo<br>Price |
|-------------|---|-----------------------------|--------------------------|---|----------------|-----------------|
| BEF         | Barbecue (tetto verniciato) (painted roof)                                | 65/80/100                   | 740x930x950              | 640x400                                 | 70             |                 |
| BTX         | Supplemento per tetto Inox<br>Surcharge for roof made in Stainless steel  |                             |                          |   |                |                 |
| GB65X       | Supplemento per griglia Inox / Surcharge for grid made in Stainless steel |                             |                          |   |                |                 |

## ES IS CASSETTO BBQ per forni / Drawer BBQ for ovens

Applicabile sui forni a combustione separata per esterno da 80; estraibile, si monta nella camera di combustione  
Installable on separated outdoor combustion ovens type "80"; it is extractable, it is mounted inside the combustion chamber



| Codice Code | Descrizione / Informazioni prodotto<br>Description / Item's info | Serie forno<br>Ovens series | Dimensioni<br>dimensions | Dimensioni griglia<br>Grid's dimensions | Peso<br>Weight | Prezzo<br>Price |
|-------------|--|-----------------------------|--------------------------|---|----------------|-----------------|
| BCF         | Barbecue estraibile / Extractable barbecue                       | 80                          |                          | 480x390                                 |                |                 |

**IS HOT HOUSE kit riscaldamento ambienti per forni /space heating kit**

Hot House è un Kit di allestimento per il forno da incasso, 65 o 80. Con questo kit si può anche riscaldare l'ambiente.

Recuperando l'energia termica in esubero, tramite questo sistema di ventilazione l'aria viene soffiata attraverso un particolare labirinto (esclusiva Rossofuoco) permettendo di riscaldare ambienti fino a 80m<sup>2</sup>; Il potenziometro in dotazione consente di regolare la quantità d'aria in uscita.

This kit, made for 65 or 80 builtin ovens, transforms them in a heating system.

With this kit the produced heat is recuperated and through a special labyrinth (a distinctive feature of Rossofuoco's ovens) is blown through the outlets; so you can heat rooms up to 80 m<sup>2</sup>. With the outcome regulator you can control the flow of the air.

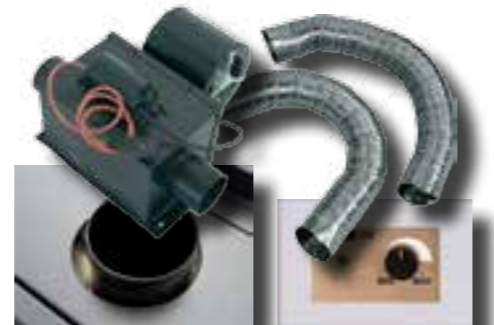

| Codice Code | Descrizione / Informazioni prodotto  | Description / Item's info  | Serie forno Ovens series | Prezzo Price |
|-------------|--|--|--------------------------|--------------|
| RA 65       | kit composto da trasformatore, motore, regolatore di velocità, 3 mt. di tubo flessibile, 2 bocchette in alluminio. | It's a kit consisting of transformer, power engine, outcome regulator, 9,84 ft. of flexible hoses, 2 outlets in aluminium. | 65                       |              |
| RA 80       |  |  | 80                       |              |

**ES Piano di lavoro laterale per forni a comb.separata /Lateral work top for separated comb. ovens**

Utilissimo pratico e robusto, ideale per appoggiarvi le teglie prima o dopo la cottura e per avere tutto a portata di mano.

It's a very practical lateral worktop for baking pans, tools...



| Codice Code | Serie forno Ovens series | Dimensioni Dimensions | Peso Weight | Prezzo Price |
|-------------|--------------------------|-----------------------|-------------|--------------|
| PA50        | 50                       | 640x300x30            |             |              |
| PA65        | 65                       | 766x300x30            |             |              |
| PA80/100    | 80/100                   | 920x300x30            |             |              |
| PAW         | Sedicinoni               | 770x300x30            |             |              |

**ES IS Mensola frontale per forni a Comb.separata/Front shelf for separated comb. ovens**

In acciaio Lucido

Made of Inox stainless steel



| Codice Code | Serie forno Ovens series | Dimensioni Dimensions | Peso Weight | Prezzo Price |
|-------------|--------------------------|-----------------------|-------------|--------------|
| PAFR        | 65/80/100                | 520x90                |             |              |

**ES Piano di lavoro frontale per "Sedicinoni"/Front work top for "Sedicinoni"**

Si appoggia sui manici estraibili del carrello

to place on the extrattable handles of the cart

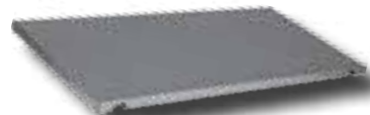

| Codice Code | Serie forno Ovens series | Dimensioni Dimensions | Peso Weight | Prezzo Price |
|-------------|--------------------------|-----------------------|-------------|--------------|
| PFW         | Sedicinoni               | 1000x350x30           |             |              |

**ED Piano laterale per forni a combustione diretta /Lateral worktop for Direct combustion ovens**

In acciaio Lucido Inox

Made of Inox stainless steel



| Codice Code | Serie forno Ovens series | Dimensioni Dimensions | Peso Weight | Prezzo Price |
|-------------|--------------------------|-----------------------|-------------|--------------|
| PAFC        | Campagnolo               | 670x350x30            |             |              |
| PAFN        | Nonna Luisa/Benni        | 770x350x30            |             |              |
| PAFP        | Piùtrecento              | 1070x350x30           |             |              |

**ES IS Piana refrattaria supplementare /Additional refractory plate**

Si può anche posare sopra la griglia centrale per cuocervi pane o pizza. It can also be placed on the central grill to bake pizza or bread directly on it.



(\*) Forno non più in produzione / oven out of production

| Codice Code | Serie forno Ovens series | Dimensioni dimensions | Peso Weight | Prezzo Price |
|-------------|--------------------------|-----------------------|-------------|--------------|
| PB50        | 50                       | 340x480x15            |             |              |
| PB65        | 65                       | 400x590x15            |             |              |
| PB80        | 80                       | 400x745x15            |             |              |
| PB100       | 100                      | 400x930x15            |             |              |
| PBWSC       | Sedicinoni               | 660x600x15            |             |              |
| PBW         | Sedicinoni ST (*)        | 660x400x15            |             |              |

**ES IS Kit porchetta (griglia + teglia raccogligrassi) / Kit for big roasts (grill + fat collection pan)**

Per cuocere le carni, in modo dietetico con l'espulsione dei grassi che cadranno nell'ampia teglia posta nel piano basso con all'interno un pò d'acqua. Ideale per cuocere la classica "Porchetta".

idela for big roasts, so the fat drops into the wide pan placed underneath and containing a little bit of water.



| Codice Code | Serie forno Ovens series | Dimensioni griglia Grill's dimensions | Peso Weight | Prezzo Price |
|-------------|--------------------------|---------------------------------------|-------------|--------------|
| GP65KIT     | 65                       | 460x550x15                            |             |              |
| GP80KIT     | 80                       | 460x700x15                            |             |              |
| GP100KIT    | 100                      | 460x900x15                            |             |              |
| GPWKIT      | Sedicinoni               | 400x550x15                            |             |              |

**ES IS Griglia per porchetta /Special grill for big roasts**

Per cuocere grosse pezzature di carne ottenendo una cottura più dietetica con l'espulsione dei grassi. ATTENZIONE: per la raccolta dei grassi usare una sottostante teglia di ampiezza adeguata con dentro un pò di acqua.

To cook large pieces of meat obtaining a more dietetic cooking. ATTENTION: for the collection of dropping ats, use an underlying tray of adequate width with some water inside.

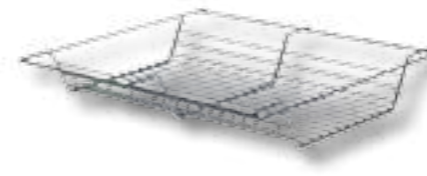

| Codice Code | Serie forno Ovens series | Dimensioni dimensions | Peso Weight | Prezzo Price |
|-------------|--------------------------|-----------------------|-------------|--------------|
| GP65        | 65                       | 460x550x15            |             |              |
| GP80        | 80                       | 460x700x15            |             |              |
| GP100       | 100                      | 460x900x15            |             |              |
| GPW         | Sedicinoni               | 400x550x15            |             |              |

**ES IS Griglia piana per forni a combustione separata /Plain grid for separated combustion ovens**

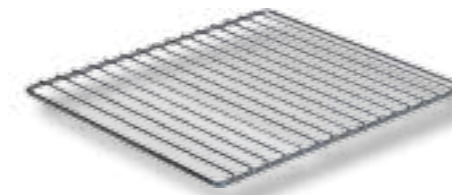

(\*) Forno non più in produzione / oven out of production

| Codice Code | Serie forno Ovens series | Dimensioni dimensions | Peso Weight | Prezzo Price |
|-------------|--------------------------|-----------------------|-------------|--------------|
| GR50        | 50                       | 390x480               |             |              |
| GR65        | 65                       | 462x550               |             |              |
| GR80        | 80                       | 462x700               |             |              |
| GR100       | 100                      | 462x900               |             |              |
| GRWXL       | Sedicinoni               | 705x600               |             |              |
| GRWST       | Sedicinoni ST (*)        | 700x462               |             |              |

**BQ Griglie per barbecue / Additional standard grids for barbecues**

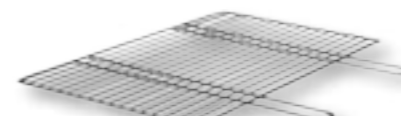

| Codice Code | Barbecue     | Barbecue             | Dimensioni dimensions | Prezzo Price |
|-------------|--------------|----------------------|-----------------------|--------------|
| GB50        | Cassetto BBQ | Cromata/Chrome       | 390x480               |              |
| GB65        | Falò/EasyUP  | Cromata/Chrome       | 640x400               |              |
| GB65X       | Falò/EasyUP  | Inox/stainless steel | 640x400               |              |
| GB80        | Maxi         | Cromata/Chrome       | 790x400               |              |
| GB80X       | Maxi         | Inox/stainless steel | 790x400               |              |

## ES IS Teglie / Baking pans



Fatte in alluminio sono disponibili in varie forme e dimensioni.

Made of aluminium, in various shapes and sizes.

| Codice Code | Descrizione / Info prodotto Description / Item's info | Dimensioni Dimensions | Prezzo Price |
|-------------|---|-----------------------|--------------|
| TL35        | Rotonda / Round                                       | Diam. 350x30          |              |
| TLQ         | Quadrata / Square                                     | 400x400x30            |              |
| TL50        | Rettangolare / Rectangular                            | 330x450x30            |              |
| TL65        | Rettangolare / Rectangular                            | 400x580x30x           |              |
| TL80        | Rettangolare / Rectangular                            | 400x680x30            |              |
| TL100       | Rettangolare / Rectangular                            | 400x880x30            |              |
| TLW         | per / for Sedicinoni                                  | 400x650x30            |              |
| TLWS (*)    | per / for Sedicinoni                                  | 2pz: 330x620x30       |              |

(\*) Set di 2 pezzi che permette di occupare tutto il piano del forno  
Set of 2 pieces that allows to occupy the whole surface of the grid

## ES IS Teglie a bordo alto / High edge baking pans



| Codice Code | Serie forno Ovens series | Dimensioni Dimensions | Prezzo Price |
|-------------|--------------------------|-----------------------|--------------|
| TLA65       | 65                       | 400x530x50            |              |
| TLA80       | 80                       | 400x680x50            |              |
| TLA100      | 100                      | 400x880x50            |              |

## ES IS Teglia a bordo alto con manici / High edge baking pan with handles



Attenzione, verificare prima dell'acquisto la dimensione della camera di cottura del proprio forno.

Warning, before ordering please verify the size of the cooking chamber of your oven.

| Codice Code | Serie forno Ovens series | Dimensioni Dimensions | Peso Weight | Prezzo Price |
|-------------|--------------------------|-----------------------|-------------|--------------|
| TLAM        |                          | 370x620x60            |             |              |

## ES IS Teglia bluita per pizza / Blue steel baking pan for pizza

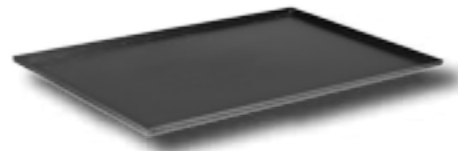

| Codice Code | Serie forno Ovens series | Dimensioni Dimensions | Peso Weight | Prezzo Price |
|-------------|--------------------------|-----------------------|-------------|--------------|
| TLB         | 65/80/100                | 600x400x20            |             |              |

## ES IS Teglia forata per pane / Perforated baking pans for bread



| Codice Code | Tipo Type                  | Dimensioni Dimensions | Prezzo Price |
|-------------|----------------------------|-----------------------|--------------|
| TLF37       | Quadrata / Square          | 370x370x30            |              |
| TLF72       | Rettangolare / Rectangular | 370x720x30            |              |

## ES IS ED Pale pane pizza / Bread and pizza shovels

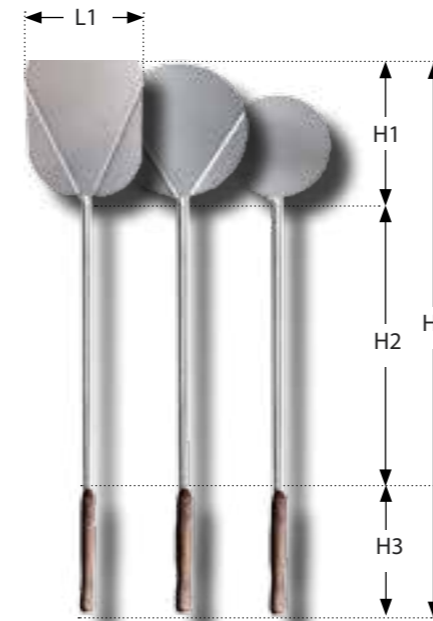

Indispensabili per infornare pane o pizza da cuocere direttamente sulla piastra refrattaria; realizzata in acciaio inox con manico cromato e terminale in legno.

Indispensable to place pizza or bread directly on the refractory plate: are made of stainless steel with chrome handle and wooden grip.

Standard / Standard

| Codice Code | Descrizione / Info prodotto Description / Item's info | Dimensioni/Dimensions |     |     |     |      | Prezzo Price |
|-------------|---|-----------------------|-----|-----|-----|------|--------------|
|             |   | L1                    | H1  | H2  | H3  | H4   |              |
| PLQ         | Pala quadrata / Squared shovel                        | 290                   | 330 | 770 | 260 | 1360 |              |
| PLR         | Pala tonda / Round shovel                             | 280                   | 280 | 770 | 260 | 1310 |              |
| PLRS        | Palino tondo / Small round shovel                     | 200                   | 200 | 770 | 260 | 1230 |              |

Per carrello modulare multiuso (CMUM) / For multi-purpose modular cart (CMUM)

| Codice Code | Descrizione / Info prodotto Description / Item's info | Dimensioni/Dimensions |     |     |     |      | Prezzo Price |
|-------------|---|-----------------------|-----|-----|-----|------|--------------|
|             |   | L1                    | H1  | H2  | H3  | H4   |              |
| PLQC        | Pala quadrata / Squared shovel                        | 290                   | 330 | 565 | 260 | 1115 |              |
| PLRC        | Pala tonda / Round shovel                             | 280                   | 280 | 565 | 260 | 1105 |              |
| PLRSC       | Palino tondo / Small round shovel                     | 200                   | 200 | 565 | 260 | 1045 |              |

## ED Accessori per la pulizia / Cleaning tools

Pensati per i forni a combustione diretta

Designed for direct combustion ovens

Accessori di pulizia standard / Standard cleaning tools

| Codice Code | Descrizione / Info prodotto Description / Item's info | Dimensioni/Dimensions |     |     |     |      | Prezzo Price |
|-------------|---|-----------------------|-----|-----|-----|------|--------------|
|             |   | L1                    | H1  | H2  | H3  | H4   |              |
| RBF         | Raccogli-spargi brace / Embers collector              | 150                   | 240 | 770 | 260 | 1270 |              |
| PCB         | Paletta per ceneri / Shovel for ashes                 | 170                   | 200 | 770 | 260 | 1230 |              |
| SCB         | Spazzola per ceneri / Brush for ashes                 | 50                    | 170 | 670 | 260 | 1200 |              |

Per carrello Cucina modulare multiuso (CMUM) / For multi-purpose modular kitchen cart (CMUM)

| Codice Code | Descrizione / Info prodotto Description / Item's info | Dimensioni/Dimensions |     |     |     |      | Prezzo Price |
|-------------|---|-----------------------|-----|-----|-----|------|--------------|
|             |   | L1                    | H1  | H2  | H3  | H4   |              |
| RBFC        | Raccogli/spargi brace / Embers collector              | 150                   | 240 | 565 | 260 | 1065 |              |
| PCBC        | Paletta per ceneri / Shovel for ashes                 | 170                   | 200 | 600 | 260 | 1060 |              |
| SCBC        | Spazzola per ceneri / Brush for ashes                 | 50                    | 170 | 520 | 260 | 1050 |              |

## ED Strumenti per VIAVAI / Tools for VIAVAI



| Codice Code | Descrizione / Info prodotto Description / Item's info | Prezzo Price |
|-------------|---|--------------|
| RBFV        | Pala teglia multiuso / Multipurpose plate             |              |
| PCBV        | Palino tondo/ Small round shovel                      |              |
| SCBV        | Spazzola per ceneri / Brush for ashes                 |              |
| PCBV        | Paletta per ceneri / Ash shovel                       |              |

## ES IS ED Porta pale / Shovel holder



| Codice Code | Descrizione / Info prodotto Description / Item's info      | Prezzo Price |
|-------------|--|--------------|
| PPL4E       | Portapale 4 posti (vuoto) / Shovel holder, 4 slots (empty) |              |
| PPL6E       | Portapale 6 posti (vuoto) / Shovel holder, 6 slots (empty) |              |



## ES IS ED Kit strumenti "QUATTRO" / Tool kit "QUATTRO"



| Codice Code | Descrizione Info prodotto   | Description Item's info   | Prezzo Price |
|-------------|---|---|--------------|
| ACK04       | Composto da:<br>Pala rettangolare PLQ, Palino rotondo PLRS,<br>Paletta ceneri PCB, Spazzola SCB                                     | Made of:<br>Squared shovel PLQ, Small round shovel PLRS,<br>Shovel for ashes PCB, Brush for ashes SCB                                 |              |
| ACK04C      | <b>Per Carrello cucina CMUM</b><br>Composto da:<br>Pala rettangolare PLQC, Palino rotondo PLRSC, Paletta ceneri PCBC, Spazzola SCBC | <b>for kitchen cart CMUM</b><br>Made of:<br>Squared shovel PLQ, Small round shovel PLRS,<br>Shovel for ashes PCB, Brush for ashes SCB |              |

## ES IS ED Kit strumenti "SEI" / Tool kit "SEI"



| Codice Code | Descrizione Info prodotto   | Description Item's info   | Prezzo Price |
|-------------|---|---|--------------|
| ACK06       | Composto da:<br>Pala rettangolare PLQ, pala rotonda PLR,<br>palino rotondo PLRS, spargibraci RBF,<br>paletta ceneri PCB, spazzola SCB | Made of:<br>Squared shovel PLQ, round shovel PLQ, small round shovel PLRS, embers collector RBF,<br>shovel for ashes PCB, brush for ashes SCB |              |

## ES ED BQ Cappottine impermeabili / Waterproof covers



| Codice Code  | Descrizione / Info prodotto Description / Item's info                | Prezzo Price |
|--|--|--------------|
| <b>Per forni a combustione separata / For separated combustion ovens</b> |  |              |
| CPFS80   | per forno da 80 / for ovens type 80                                  |              |
| CPFS100  | per forno da 100 / for ovens type 100                                |              |
| CPFSSN   | per forno "Sedicinoni" / for oven "Sedicinoni"                       |              |
| <b>Per forni a combustione diretta / For direct combustion ovens</b>     |  |              |
| CPFDNL   | per forni "Nonna Luisa" e Benni / for oven "Nonna Luisa" and "Benni" |              |
| CPFDPT   | per forno "Più trecento" / for oven "Più trecento"                   |              |
| <b>Per barbecue Stand alone / For stand alone barbecue</b>               |  |              |
| CPBBEU   | per barbecue "Easy UP" / for "Easy UP" barbecue                      |              |
| CPBBMX   | per barbecue "Maxi" / for "Maxi" barbecue                            |              |
| <b>Per Riscaldatori pirolitici / For outdoor patio heaters</b>           |  |              |
| CPRPRB   | per riscaldatore "Rubino" / for "Rubino" heater                      |              |
| CPRPDM   | per riscaldatore "Diamante" / for "Diamante" heater                  |              |

## ES IS BQ Accenditore per carbonella / Charcoal fire starter



Un accessorio utilissimo che consente di accendere rapidamente la carbonella per il barbecue; sarà sufficiente inserire la carbonella nella parte superiore accendendo poi sotto il nostro strumento un comunissimo cubetto "accendi fuoco".

A very useful tool that allows to fire and to get quickly ready the charcoal for the barbecue; just putting some coal in the upper part and lighting a firestarter block/stick in the lower part.

| Codice Code | per For                          | Info prodotto Item's info | Prezzo Price |
|-------------|----------------------------------|---------------------------|--------------|
| ACF         | Barbecue forni / Oven's Barbecue | Verniciato / Painted      |              |
| ACB         | Easy UP                          | Verniciato / Painted      |              |

## BQ Piani laterali per "Easy Up" verniciati / Lateral painted work tops for "Easy Up"



| Codice Code | Info prodotto Item's info              | per For | Dimensioni Dimensions | Prezzo Price |
|-------------|--|---------|-----------------------|--------------|
| PBV         | 2 piani verniciati / 2 painted shelves | Easy UP | 440X300               |              |

**ED Ricambi per bruciatori a gas / Spare parts for Gas burners**



**Bruciatore a gas / Gas burners**

| Codice Code | per For                   | Info prodotto Item's info                     | Prezzo Price |
|-------------|---------------------------|---|--------------|
| FDGASB1E    | Nonna Luisa, Più trecento | Certificazione Europea European Certification |              |
| FDGASB1U    | Nonna Luisa, Più trecento | Certificazione Statunitense US Certification  |              |

**ATTENZIONE:** in fase di ordine comunicare il tipo di gas che viene utilizzato ed in che paese.

**WARNING:** when ordering, communicate the type of gas that is used and in which country

| Dati tecnici del bruciatore a gas |  | Technical data of the gas burner |  |
|-----------------------------------|--|----------------------------------|--|
| Potenza termica                   | da 5,7 a 16kw a seconda del gas utilizzato     | Thermal power                    | from 5,7 to 16kw depending on the type of gas  |
| Consumo                           | da 0,6 a 2,7 kg/h a seconda del gas utilizzato | Consumption                      | da 0,6 a 2,7 kg/h depending on the type of gas |
| Peso / Weight                     | 7,5 kg   | Weight                           | 7,5 kg   |
| Tipo di allacciamento gas         | 1/2 BSP/G                                      | type of gas connection           | 1/2 BSP/G                                      |
| Rendimento combustione            | 80%  | Combustion efficiency            | 80%  |



**Frangi fiamma per bruciatore a gas / Flame distributor for gas burner**

| Codice Code | per For                   | Info prodotto Item's info | Prezzo Price |
|-------------|---------------------------|---------------------------|--------------|
| FDGASFF     | Nonna Luisa, Più trecento | Inox / Stainless steel    |              |

**Mattone per forni con bruciatore a gas / Brick for ovens with gas burner**

| Codice Code | per For                   | Info prodotto Item's info | Prezzo Price |
|-------------|---------------------------|---------------------------|--------------|
| FDGASMX     | Nonna Luisa, Più trecento | Inox / Stainless steel    |              |

**PH Ricambi per riscaldatori / Spare parts for heaters**



| Codice Code | Per for         | Descrizione / Info prodotto Description / Item's info    | Prezzo Price |
|-------------|-----------------|--|--------------|
| RIRPTVB     | Rubino          | Tubo vetro borosilicato / Borosilicate glass tube        |              |
| RIRPVTS     | Diamante        | Vetro singolo serigrafato / Single screen-printed glass  |              |
| RIRPSUV     | Diamante        | Supporto singolo per vetro / Single glass holder         |              |
| RIRPGUB     | Rubino/Diamante | Coppia guide inox bruciatore / Pair of guides for burner |              |
| RIRPCHB     | Rubino/Diamante | Chiusura con chiave sportello / Lock with door key       |              |
| RIRPRUS     | Rubino/Diamante | Ruota singola per bruciatore / Single wheel for burner   |              |
| RIRPPIS     | Rubino/Diamante | pedino basamento bruciatore / Single base foot           |              |
| RIRPFAB     | Rubino/Diamante | Farfalla bruciatore / Extractable burner base            |              |

**BQ Braciere brucialegna per Falò/ Brazier for "Falò"**



| Codice Code | Descrizione / Info prodotto Description / Item's info | Dimensioni Dimensions | Prezzo Price |
|-------------|---|-----------------------|--------------|
| RI BRF      | Per barbecue "Falò" / for barbecue "Falò"             |                       |              |

**ED Braciere brucialegna / Brazier**



| Codice Code | Descrizione / Info prodotto Description / Item's info               | Dimensioni Dimensions | Prezzo Price |
|-------------|---|-----------------------|--------------|
| RI BRD      | Per forni a cottura diretta a legna / for wood fueled cooking ovens |                       |              |

**ED Mattone refrattario / Refractory brick**



| Codice Code | Descrizione / Info prodotto Description / Item's info               | Dimensioni Dimensions | Prezzo Price |
|-------------|---|-----------------------|--------------|
| FDLEGMR     | Per forni a cottura diretta a legna / for wood fueled cooking ovens | 200x300               |              |

**ED Kit braciere + refrattario / Kit Brazier + Refractory brick**



Consente la trasformazione del forno a cottura diretta, da versione a Gas a versione a Legna / Allows the transformation of a direct cooking oven, from Gas version to Wood version

| Codice Code | Descrizione / Info prodotto Description / Item's info               | Dimensioni Dimensions | Prezzo Price |
|-------------|---|-----------------------|--------------|
| FDGASKBM    | Per forni a cottura diretta a legna / for wood fueled cooking ovens |                       |              |

**ES ED BQ Comignoli / Chimneys**



| Codice Code | Descrizione / Info prodotto Description / Item's info | per For   | Dimensioni Dimensions | Prezzo Price |
|-------------|---|---|-----------------------|--------------|
| RICM060     | Comignolo h 600                                       | Forni a combustione separata Separated combustion ovens | h 600 - Ø 130         |              |
| RICM100     | Comignolo h 1000                                      |   | h 1000 - Ø 130        |              |

| Codice Code | Descrizione / Info prodotto Description / Item's info | per For                                       | Dimensioni Dimensions | Prezzo Price |
|-------------|---|---|-----------------------|--------------|
| RICMCB      | Corpo comignolo Chimney body                          | Barbecue "Falò"                               | Ø 130                 |              |
| RICMCD      | Corpo comignolo Chimney body                          | Forni a cottura diretta / Direct cooking oven | Ø 150                 |              |
| RICMCDB     | Corpo comignolo con valvola Chimney body with valve   | Forno BENNI \ Oven BENNI                      | Ø 130                 |              |
| RICMCDM     | Corpo comignolo con valvola Chimney body with valve   | Forno MINO \ Oven MINO                        | Ø 100                 |              |

| Codice Code | Descrizione / Info prodotto Description / Item's info | per For   | Dimensioni dimensions | Prezzo Price |
|-------------|---|---|-----------------------|--------------|
| RICMCA      | Cappello comignolo Chimney cap                        | Campagnolo / Nonnaluisa / Più trecento                  | Ø 150                 |              |
| RICMCAB     | Cappello comignolo Chimney cap                        | Forno BENNI \ Oven BENNI                                | Ø 130                 |              |
| RICMCAM     | Cappello comignolo Chimney cap                        | Forno MINO \ Oven MINO                                  | Ø 100                 |              |
| RICMCV      | Cappello comignolo Antivento Windproof chimney cap    | Forni a combustione separata Separated combustion ovens | Ø 130                 |              |

**ES** **IS** **Tetto interno per "Garden" / Internal roof for "Garden"**



| Codice Code | Descrizione / Info prodotto Description / Item's info  | Dimensioni Dimensions | Prezzo Price |
|-------------|--|-----------------------|--------------|
| RITIG80     | Per forno "Garden" da 80 / for oven "Garden" type 80   |                       |              |
| RITIG100    | Per forno "Garden" da 100 / for oven "Garden" type 100 |                       |              |

**ES** **IS** **Griglia fuoco per forni a comb. separata / Fire grill for separated comb. ovens**

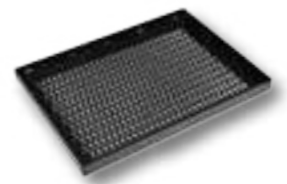

| Codice Code | Descrizione / Info prodotto Description / Item's info | Dimensioni Dimensions | Prezzo Price |
|-------------|---|-----------------------|--------------|
| RIGRF50     | Per forni serie 50 / for series 50 ovens              |                       |              |
| RIGRF65     | Per forni serie 65 / for series 65 ovens              |                       |              |
| RIGRF80     | Per forni serie 80 / for series 80 ovens              |                       |              |
| RIGRF100    | Per forni serie 100 / for series 100 ovens            |                       |              |
| RIGRFW      | Per "Sedicinoni" / for "Sedicinoni"                   |                       |              |

**ES** **IS** **Cassetto cenere per forni a comb. separata / Ash tray for separated comb. ovens**



| Codice Code | Descrizione / Info prodotto Description / Item's info | Dimensioni Dimensions | Prezzo Price |
|-------------|---|-----------------------|--------------|
| RICCF50     | Per forni serie 50 / for series 50 ovens              |                       |              |
| RICCF65     | Per forni serie 65 / for series 65 ovens              |                       |              |
| RICCF80     | Per forni serie 80 / for series 80 ovens              |                       |              |
| RICCF100    | Per forni serie 100 / for series 100 ovens            |                       |              |
| RICCFW      | Per "Sedicinoni" / for "Sedicinoni"                   |                       |              |

**ES** **IS** **Maniglie per forni a comb. separata / Handles for separated comb. ovens**



| Codice Code | Descrizione / Info prodotto Description / Item's info                           | Dimensioni Dimensions | Prezzo Price |
|-------------|---|-----------------------|--------------|
| RIMMO       | Molla di finitura per maniglia standard<br>Finishing spring for standard handle |                       |              |
| RIMLI       | Maniglia "Line"<br>"Line" handle  |                       |              |
| RIMW        | Maniglia per "Sedicinoni"<br>Handle for "Sedicinoni"                            |                       |              |

**ES** **IS** **Coppia cerniere sportelli / Pair of hinges for doors**



| Codice Code | per For    | Dimensioni Dimensions | Prezzo Price |
|-------------|------------|-----------------------|--------------|
| RICEW       | Sedicinoni |                       |              |

**ES** **IS** **Pomelli per forni a comb. separata / Knobs for separated comb. ovens**



| Codice Code | Descrizione / Info prodotto Description / Item's info     | Dimensioni Dimensions | Prezzo Price |
|-------------|---|-----------------------|--------------|
| RIPOV       | Pomello valvole fumi o vapore<br>Fume or steam valve knob |                       |              |
| RIPOA       | Pomello controllo areazione<br>Ventilation control knob   |                       |              |

**ES** **IS** **Kit ventilazione per forni ventilati / Ventilation kit for fan ovens**



| Codice Code | Descrizione / Info prodotto Description / Item's info                      | Dimensioni Dimensions | Prezzo Price |
|-------------|--|-----------------------|--------------|
| RIKVE       | Motore e ventola per forni ventilati / Engine and fan for ventilated ovens |                       |              |

**ES** **IS** **Trasformatore / AC adapter**



| Codice Code | Descrizione / Info prodotto Description / Item's info  | Dimensioni Dimensions | Prezzo Price |
|-------------|--|-----------------------|--------------|
| RITRF       | Trasformatore elettrico da 220/230V a 12V per alimentazione elettrica forno<br>AC adapter from 220 / 230V to 12V for oven power supply |                       |              |

**ES** **IS** **Kit guarnizione sportello / Door gasket kit**



| Codice Code | Descrizione / Info prodotto Description / Item's info  | Dimensioni Dimensions | Prezzo Price |
|-------------|--|-----------------------|--------------|
| RIGAC       | Guarnizione di ricambio per sportello camera di combustione dei forni a combustione separata<br>Spare gasket for combustion chamber door of separated combustion ovens |                       |              |

**ES** **IS** **Illuminazione camera di cottura / Lighting of the cooking chamber**



| Codice Code | Descrizione / Info prodotto Description / Item's info  | Dimensioni Dimensions | Prezzo Price |
|-------------|--|-----------------------|--------------|
| RIPLC       | Portalamпада completo per sistema di illuminazione interno della camera di cottura dei forni a combustione separata<br>Complete lamp holder for internal lighting system of the cooking chamber of separate combustion ovens |                       |              |
| RILAM       | Lampadina di ricambio per sistema di illuminazione interno della camera di cottura dei forni a combustione separata<br>Replacement bulb for internal lighting system of the cooking chamber of separate combustion ovens     |                       |              |



**ES IS Interruttori / Switches**

| Codice Code | Descrizione / Info prodotto Description / Item's info                                 | Dimensioni Dimensions | Prezzo Price |
|-------------|---|-----------------------|--------------|
| RIINM       | Coppia interruttori in struttura metallica<br>Pair of switches in metal structure     |                       |              |
| RIINP       | Coppia interruttori in struttura di plastica<br>Pair of switches in plastic structure |                       |              |

**ES IS ED Termometri / Thermometers**

| Codice Code | Descrizione / Info prodotto Description / Item's info   | Dimensioni Dimensions | Prezzo Price |
|-------------|---|-----------------------|--------------|
| RITMB1      | Termometro a bulbo per forni serie 50<br>Bulb thermometer for 50 series ovens                   |                       |              |
| RITMB2      | Termometro a bulbo esclusi forni serie 50<br>Bulb thermometer for all ovens except 50 series    |                       |              |
| RITMST      | Termometro a staffa per forni a cottura diretta<br>Bracket thermometer for direct cooking ovens |                       |              |
| RITMIR      | Termometro laser digitale ad infrarossi per MINO<br>Infrared digital laser thermometer for MINO |                       |              |

**ES IS Timer / Timer**

| Codice Code | Descrizione / Info prodotto Description / Item's info | Dimensioni Dimensions | Prezzo Price |
|-------------|---|-----------------------|--------------|
| RITRM       | Contaminuti<br>Timer                                  |                       |              |

**ES ED Ruote / Wheels**

| Codice Code | Descrizione / Info prodotto Description / Item's info   | Dimensioni Dimensions | Prezzo Price |
|-------------|---|-----------------------|--------------|
| RIRUC       | Ruota singola per carrello forni a combustione separata<br>Single wheel for carts of separate combustion ovens            |                       |              |
| RIRUT       | Ruota singola per carrelli forni a cottura diretta<br>Single wheel for carts of direct cooking ovens                      |                       |              |
| RIRUTF      | Ruota singola per carrelli forni a cottura diretta con freno<br>Single wheel with brake for carts of direct cooking ovens |                       |              |

**Sedicioni**

| Frontale Front  | Fianchi Sides | Tetto Roof      |
|-----------------|---------------|-----------------|
| Acciaio (Steel) | Nero (Black)  | Marrone (Brown) |
|                 | Nero (Black)  | Acciaio (Steel) |

**Steel**

| Frontale Front  | Fianchi Sides | Tetto Roof      |
|-----------------|---------------|-----------------|
| Acciaio (Steel) | Nero (Black)  | Acciaio (Steel) |

**Rame**

| Struttura Body |
|----------------|
| Nero (Black)   |

**Red**

| Struttura Body |
|----------------|
| Rosso (red)    |

**Fiamma - Effe - Eco - Eco50**

| Struttura Body          | Tetto Roof      |
|-------------------------|-----------------|
| Grigio Lava (Lava grey) | Nero (Black)    |
|                         | Acciaio (Steel) |

**Raggio**

| Struttura Body               | Tetto Roof   |
|------------------------------|--------------|
| Marrone ossido (Oxide Brown) | Nero (Black) |

**Garden Garden plus**

| Struttura Body  | Tetto Roof      |
|-----------------|-----------------|
| Marrone (Brown) | Rosso (red)     |
|                 | Acciaio (Steel) |

**Garden color**

| Frontale Front          | Fianchi Sides           | Tetto Roof      |
|-------------------------|-------------------------|-----------------|
| Grigio Lava (Lava grey) | Marrone (Brown)         | Grigio (Grey)   |
|                         | Rosso (Red)             | Rosso (Red)     |
|                         | Grigio Lava (Lava Grey) | Acciaio (Steel) |
|                         | Marrone (Brown)         |                 |
|                         | Panna (Cream)           |                 |

**Più trecento**

| Carter Crankcase | Carrello Cart |
|------------------|---------------|
| Rosso (Red)      | Nero (Black)  |

**Campagnolo, Nonna Luisa**

| Carter Crankcase | Carrello Cart   |
|------------------|-----------------|
| Rosso (Red)      | Marrone (Brown) |
|                  | Nero (Black)    |
|                  | Acciaio (Steel) |

**Benni**

| Carter Crankcase             | Carrello Cart   |
|------------------------------|-----------------|
| Marrone ossido (Oxide Brown) | Nero (Black)    |
|                              | Acciaio (Steel) |

**Mino**

| Carter Crankcase |
|------------------|
| Arancio (Orange) |

Le colorazioni sono riportate a titolo esemplificativo e non esaustivo. Per ragioni tecniche di stampa e/o per variazioni intervenute nella produzione di materie e materiali e/o per il lotto di appartenenza dei medesimi, i colori riportati nel presente catalogo, possono differire dagli originali.

The colors are given as an example and not limited to. For technical reasons of printing and / or for variations in the production of materials and materials and / or for the batch to which they belong, the colors shown in this catalog may differ from the originals.

## Note, termini e condizioni commerciali

### Colori, modelli, finiture e caratteristiche tecniche

Quanto riportato nel presente catalogo ha valore esclusivamente illustrativo e non costituisce offerta al pubblico. L'azienda si riserva il diritto di apportare modifiche, anche senza preavviso ai prodotti qui illustrati.

Le colorazioni sono riportate a titolo esemplificativo e non esaustivo in quanto, per ragioni tecniche di stampa e/o per variazioni intervenute nella produzione di materie e materiali e/o per il lotto di appartenenza dei medesimi, i colori riportati nel presente catalogo, possono differire dagli originali.

### Prezzi di listino

I prezzi pubblicati nel presente catalogo fanno riferimento al listino correntemente in corso **n. 01.2020**

I prezzi sono validi e correnti al momento della pubblicazione di questo catalogo, ma potrebbero subire variazioni nel tempo che potranno essere pubblicate solo in occasioni di stampe successive, quindi prima di effettuare qualsiasi ordine verificare la validità del listino corrente e dei prezzi in esso riportati.

### Prezzi

Franco nostro stabilimento e con imballo al costo.

### Ordini

Tutti gli ordini sono subordinati all'accettazione da parte del produttore.

### Termini di consegna

La data di consegna anche se confermata è comunque indicativa, eventuali ritardi non daranno diritto ad annullamento dell'ordine o risarcimento.

### Resa in Italia

Franco nostro stabilimento.

### Contestazioni

La merce viaggia sempre a rischio e pericolo del committente anche se inviata franco destino; controllare la merce all'atto del ritiro e contestare immediatamente al vettore mancanze o avarie, con riserva scritta sul documento di trasporto; in mancanza di ciò la consegna si intende accettata senza alcuna riserva.

Eventuali altri reclami, non imputabili a quanto sopra dovranno pervenirci per iscritto entro 8 (otto) giorni dal ricevimento delle merci.

Non si accettano ritorni di merce se non espressamente autorizzati per iscritto dal produttore.

### Pagamenti

Sono riconosciuti validi solo i pagamenti effettuati direttamente al produttore o tramite istituti bancari.

Nel caso di ritardato pagamento decorreranno gli interessi di mora al tasso bancario in vigore e l'evasione di eventuali ordini in corso o successivi verrà sospesa.

Si precisa che le vendite si intendono eseguite in condizioni di "sospensiva", per cui la merce rimane di proprietà del produttore sino al totale pagamento.

In mancanza di pagamento a saldo gli eventuali acconti già effettuati resteranno acquisiti dal produttore a titolo di rimborso spese, danni e deprezzamento merce.

### Modifiche

Il produttore si riserva il diritto di modificare le caratteristiche costruttive e le dimensioni in ogni momento senza alcun preavviso.

### Foro competente

Per qualsiasi controversia il Foro competente sarà quello nell'ambito del quale ha sede il produttore.

## Note, commercial terms and conditions

### Colors, models, finishes and technical characteristics

The contents of this catalog are for illustrative purposes only and do not constitute an offer to the public. The company reserves the right to make changes, even without notice, to the products shown here.

The colors are given by way of example and not limited to the fact that, for technical printing reasons and / or for changes in the production of materials and / or for the batch they belong to, the colors shown in this catalog may differ from the originals.

### List prices

The prices published in this catalog refer to the current price list: **n. 01.2020**

The prices are valid and current at the time of publication of this catalog, but may vary over time which can only be published on the occasion of subsequent prints, therefore before making any order, check the validity of the current price list and of the prices reported therein.

### Prices

Ex-works from our factory and packaged at cost

### Orders

All orders are subject to acceptance by the manufacturer.

### Terms of delivery

The delivery date, even if confirmed, is still indicative, any delays will not give the right to cancel the order or compensation.

### Deliveries in Italy

Ex our factory.

### Disputes

The goods always travel at the customer's risk even if sent carriage paid; check the goods upon collection and immediately notify the carrier of shortcomings or failures, with a written reservation on the transport document; in the absence of this, delivery is considered accepted without reservation.

Any other complaints, not attributable to the above, must reach us in writing within 8 (eight) days of receipt of the goods.

Returns of goods are not accepted unless expressly authorized in writing by the manufacturer.

### Payments

Only payments made directly to the manufacturer or through banking institutions are recognized as valid.

In case of late payment, interest on arrears will start at the current bank rate and the processing of any orders in progress or later will be suspended.

It should be noted that sales are considered to be carried out under "suspension" conditions, whereby the goods remain the property of the producer until full payment.

In the absence of full payment, any advance payments already made will remain acquired by the manufacturer by way of reimbursement of expenses, damage and depreciation of the goods.

### Changes

The manufacturer reserves the right to modify the construction characteristics and dimensions at any time without notice.

### Jurisdiction

For any dispute, the competent court will be the one in which the manufacturer is based.

*Gentile rivenditore, nel ringraziarla per l'interesse accordatoci, siamo a ricordarle le varie modalità possibili per ricevere ulteriori informazioni e supporto alla vendita, nonché per l'inoltro degli ordini:*

Il suo agente di zona è:

\_\_\_\_\_

contattabile ai seguenti recapiti:

Tel.: \_\_\_\_\_ Cellulare: \_\_\_\_\_

Fax: \_\_\_\_\_ e-mail: \_\_\_\_\_

*Potra' quindi inoltrare direttamente gli ordini al suo agente utilizzando uno dei recapiti sopra indicati.*

### RIVENDITORE AUTORIZZATO

© Rossofuoco srl unipersonale 2020.- Opera protetta da copyright. - Catalogo 01/2020 - Tutte le immagini e/o i testi presenti in questo catalogo sono coperte dal diritto d'autore, ne è quindi vietato l'utilizzo anche parziale senza autorizzazione scritta dell'autore.  
Grafica by grafide@btpoint.eu +393355936050

© Rossofuoco srl 2020 - Work protected by copyright. - Catalogo 01/2020 - All pictures and/or texts of this catalog are protected by copyright; any use, even partial, is forbidden without authorization. - Graphic by grafide@btpoint.eu +393355936050



**WWW.ROSSOFUOCO.COM**



**Pagina Facebook :**  
*acquisisci il QRcode a fianco  
con il tuo smartphone o tablet, o cerca:  
"RossoFuoco Forni" in Facebook.*



**Canale Youtube :**  
*acquisisci il QRcode a fianco  
con il tuo smartphone o tablet, o cerca:  
"RossoFuoco Pizza" in youtube.*



**Instagram :**  
*acquisisci il QRcode a fianco  
con il tuo smartphone o tablet, o cerca:  
"rossofuoco\_fornibarbecues" su Instagram.*



Realizzati e distribuiti da / Made and distributed by  
Rossofuoco s.r.l. unipersonale  
Via Cavalieri di Vittorio Veneto, 21 - 61045 PERGOLA (PU) - ITALY  
tel +39 0721 735926 - fax +39 0721 737107  
mail: info@rossofuoco.com