MANUAL AND INSTRUCTION

WESTBO WeRa M1



Westbo of Sweden

Building notification

Before installation of the fireplace and construction of a chimney, it is a demand to do a building notification. For piece of advise, contact your local authorities.

When receiving the stove

When the stove is received it is important to check the goods to see that the stove is not damaged during the transport. Damages should be notified to the freight company immediately.

Floor protection

The floor protection prevents the floor in front of the stove from sparks. Check your local regulations by your domestic authorities.

Flue inspection

A good piece of advice when installing to the existing chimney is to before start, contact the Chimney sweeper for inspection. The Chimney sweeper can recommend possible need for chimney renovation. After installing the fireplace, it must be inspected by a Chimney sweeper again before it is put into operation.

Supporting material

The product weight is 100 kg and can be placed on an ordinary floor.

Combustible and non-combustible wall

The stove does not require a firewall but is approved to place it 400 mm from the back edge to the combustible wall. When placed against non-combustible wall (firewall), a minimum distance of 50 mm must be kept.

Heating and care instructions

See in particular section in this guide.

Standards

National and European standards, building regulations and rules must be observed. Therefore, inform your Chimney sweeper in advance.

The chimney calculation is carried out according to DIN EN 132 40.

Please read this brochure carefully and the chimney suppliers instructions before starting assembly.

Good luck with your new fireplace.

Westbo of Sweden

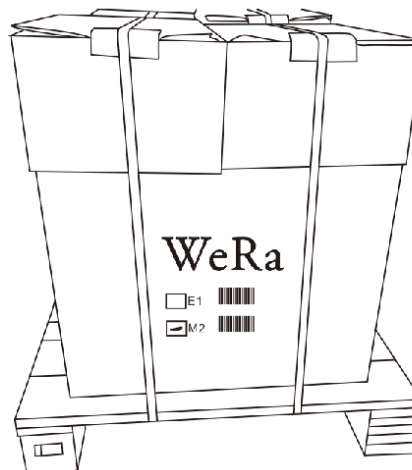

Westbo of Sweden

Legs and Chamotte bricks must be mounted in the firebox.
Use mounting option one or two.

Including:

- 4 Legs and screws
- 6 Chamotte bricks
- 1 Air box
- 1 Handle
- 1 Smoke pipe 125 mm in diameter

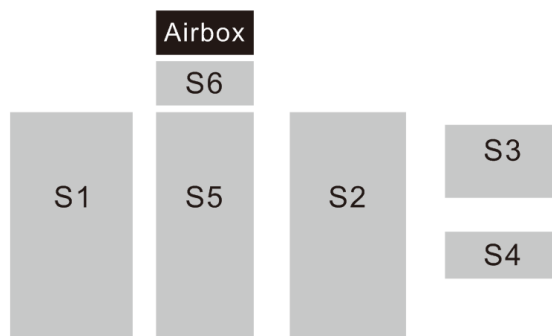

Chamotte bricks

Combined with the stove there are six Chamotte bricks.

S1 och S2 - Side bricks

S 5 - Bottom brick

S 6 - Rear brick

S 3 -and S 4 - Baffle plates

Place the bricks shown on this page.

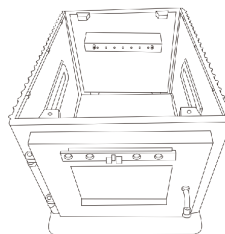

Legs and Chamotte bricks must be mounted on the firebox.
Use mounting options one or two.

1. Disassemble the top plate from the firebox and lift it off.
First, place the left side brick (S1) in the firebox.

2. Then insert the second side brick (S2).

Be careful on the orientation of the side stones so the airholes are in correct position.

3. Then insert the bottom brick (S5) and the rear brick (S6).

4. Place the baffle plates (S3) and (S4) towards the back so the gap for the smoke is in the front.

Reassemble the top plate.

The fireplace is now ready. Install the handle.

In some cases, a smaller piece of the side brick (S2) needs to be knocked away in order to that handles and door should be able to close correctly.

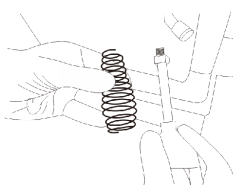
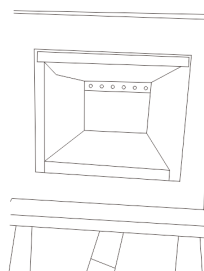
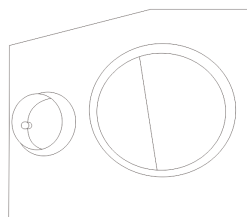

Safety

Westbo WeRa M1 is tested according to standard DIN 13240. The stove is room air dependent, i.e., the combustion air is consumed from the installation room.

Make sure that an adequate air supply is ensured.

The stove is equipped with a control for supply air to the combustion and is located above the firebox.

Observe the distances to flammable objects. Do not leave paper, newspapers or other combustible materials near the stove.

The stove can be hot!

Risk of burns on all surfaces: combustion chamber door, door and control handles, smoke pipes and the front of the stove.

Do not leave children unattended near the stove.

Empty the ashes

Never drain ash into a combustible vessel, preferably use a sheet metal vessel with a tight fitting lid. There may be ember residues in the ashes several days after the end of the fire.

Smell

At the first firing, some odors may appear.

It is due to certain coatings on the plate that are burned off.

The smell disappears after a couple of bonfires.

First fire

We advise you to use ignition pads or equivalent. With the help of these, there will be a quick over ignition of the wood and a cleaner combustion.

Never use lighter fluid.

At first ignition, the supply air control shall be fully opened.

Put in about 1-2 kilograms of kindling wood (thin logs).

Put a 2-3 kindling pads on top and light on. Close the door when the fire has started. With this method, there will be a quick over ignition and it minimizes soot coating on the glass.

When filling wood, carefully open the door so that smoke rash is avoided. Never fill up with wood as long as it burns a lot.

Continuous firing

It is important to get the right temperature in the fireplace. Then the stove and wood are utilized to the maximum and there will be a clean combustion. Soot coating in the firebox and on the glass is also avoided.

When fired correctly, the smoke should not be visible, but only perceived as a dripping in the air.

In the case of a good ember bed after the ignition phase, the actual firing can begin with the right amount of firewood.

Now adjust the supply air control relative to the draught in the chimney. It should burn well, if it is strangled too much, there is a risk of soot coating in the firebox, as well as sooting on the glass.

Recommend amount of wood

We recommend smaller wood logs, that can be placed in the stove. Length of wood is approximately 30 cm and at the most 3 kg. The maximum amount of wood allowed is approximately 3 kg per hour for dry cut birch wood.

Sweeping

Sweeping should be done by the Chimney sweeper.

Sweeping of the stove can be done by scraping down and/or brushing. To collect the ashes, the most suitable is to use a soot vacuum cleaner.

Chimney fire

If a chimney fire occurs or is feared, dampers and hatches must be closed. If necessary, contact emergency services for extinguishing. After a chimney fire, the chimney must always be inspected.



Preparation

We recommend a diameter of 6-10 centimetre and that the wood logs are 6 centimetre shorter than the fireplace. This will help the air to circulate in the best possible way. If the diameter is bigger, the wood logs must be splitted. Wood logs that are splitted will dry better.

Storage

The splitted wood logs should be stored for 1-2 years before usage. If the wood is put in piles it will dry faster. Before use, store the wood in room temperature. Please keep in mind that the wood during Autumn and Winter absorbs moist from the air.

Moisture

To avoid environmental problems and to get the best fueling economy, the wood logs must be dried before use. They should contain maximum 21% moisture. Best performance of the wood logs is achieved by a moisture level of 15-18%. A simple test is to beat two wood logs against each other. If a numb sound occurs, the wood contains too much moist.

By using moist wood logs, large amount of the heat will be used to evaporate the water. The stove will therefore not be warm. This is of course uneconomic and there will be soot on the glass hatches, inside the stove and in the chimney. The environment will also be contaminated.

What is correct amount of wood logs?

How much is a kilo of wood? Or how do you handle the wood in a correct way? There are literature to buy regarding wood knowledge. It is a good thing to acquire a little more knowledge on the subject than what we communicate here.

It is absolutely forbidden to fire:

Painted, pressure-treated or glued wood. Neither is chipboard, plastic, or treated paper suitable to fire. The substances contained in these products are harmful both to the environment and to the stove. Even the chimney can be attacked if you use material mentioned above.

Simply put, fire only clean wood logs.

Calorific wood value

The calorific wood value varies between wood species. On some you need to put a bit more wood into the fireplace to get the same amount of heat like other wood species. In our firing instructions, we calculate with birch wood, which has a very good calorific value and is the type of wood we recommend. By burning oak or beech, keep in mind that these types of wood have a higher calorific value than birch. Wood logs must also be reduced so the stove won't be damaged. Pine and spruce have higher calorific value than birch.



Technical data

Weight	100 kg
Height	70 cm
Width	39,1 cm
Deep	410 cm
Cooking plate	219 mm diameter
Smoke channel	120-125mm diameter
Material	Cast iron
Medium power	4,5kW
Efficiency	81%
Distance to combustable wall/side	400 mm
CE-approved	According to EN 13240

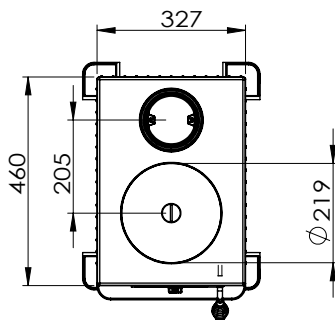
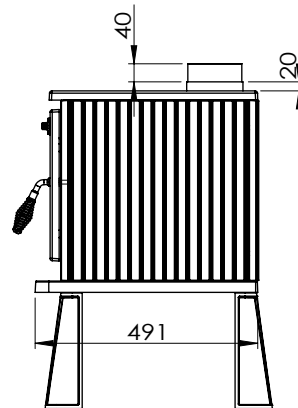
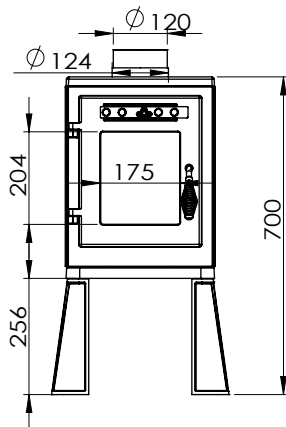



westbo of sweden

WARRANTY

Westbo of Sweden has a 15 year stove casting warranty and a 1 year warranty concerning natural wear and tear of articles of consumption such as firebricks, vermiculite, grates, glass, handles and rope seal.

The warranty is only valid if the stove has been used in a proper way according to the instructions and will not be valid if any extreme or careless handling has occurred like overheating, wrong fuel or too much wood etc.

Westbo of Sweden is obligated to provide new parts/stove if any defects covered by the warranty occurred, but takes no responsibility for removal or installation costs for the exchange.

The warranty covers only the product and the buyer is not entitled to compensation for any personal or property damage.

Yours sincerely
Mattias Gunnarsson
Managing director



Westbo of Sweden